

REV.	DATE	DRAWN BY	DESCRIPTION

Carl P. O'Brien
Carl P. O'Brien
NEW JERSEY LICENSED PROFESSIONAL ENGINEER
LICENSE NUMBER: 645154
COLLIERS ENGINEERING & DESIGN, INC.
N.J. C.O.A. #: 24GA27986500

CONSTRUCTION PLANS
FOR
2022 VARIOUS
DRAINAGE
IMPROVEMENTS
TOWNSHIP OF CRANFORD
COUNTY OF UNION
NEW JERSEY

Colliers Engineering & Design
MT. ARLINGTON
400 Valley Road,
Suite 304
Mt. Arlington, NJ 07856
Phone: 973.398.3110
COLLIERS ENGINEERING & DESIGN, INC.
DOING BUSINESS AS MASER CONSULTING

SCALE: AS SHOWN	DATE: 09/23/2022	DRAWN BY: AP	CHECKED BY: PC
PROJECT NUMBER: CDT0083	DRAWING NAME: C-LAY1-RETF		

DIMENSION PLAN - RETFORD AVENUE

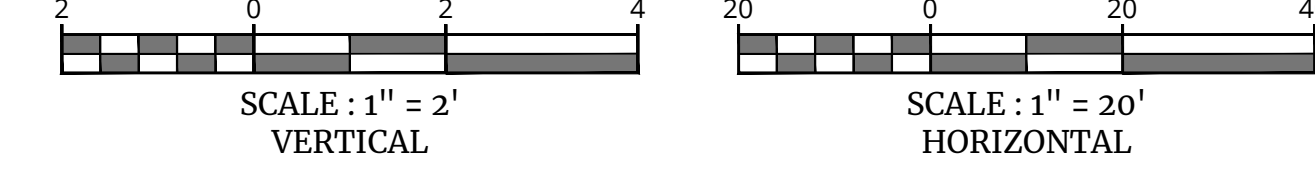
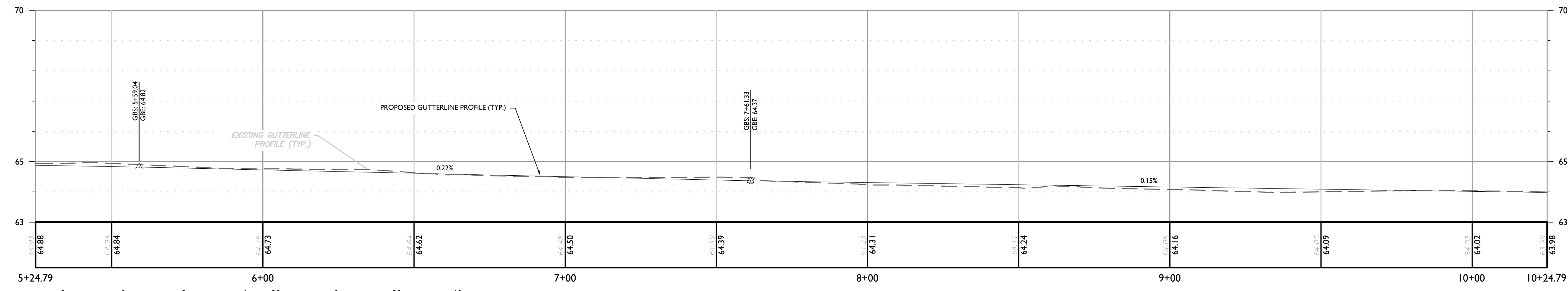
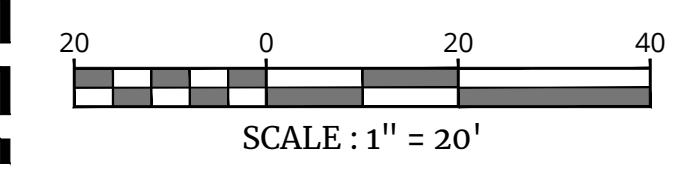
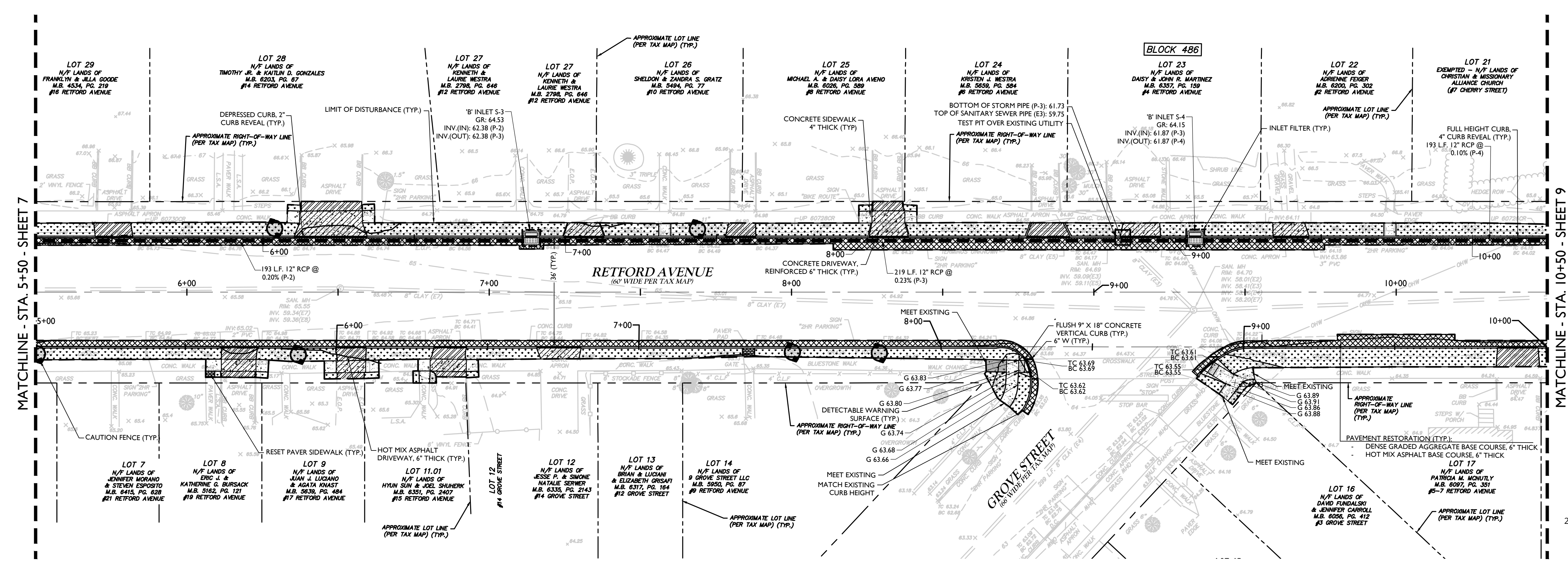
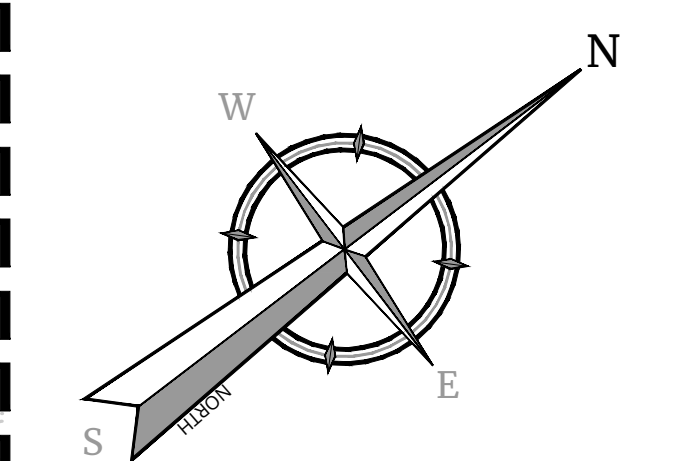

PROFILE OF RETFORD AVENUE NORTHERN GUTTERLINE
HORIZONTAL : 1" = 20'
VERTICAL : 1" = 2'

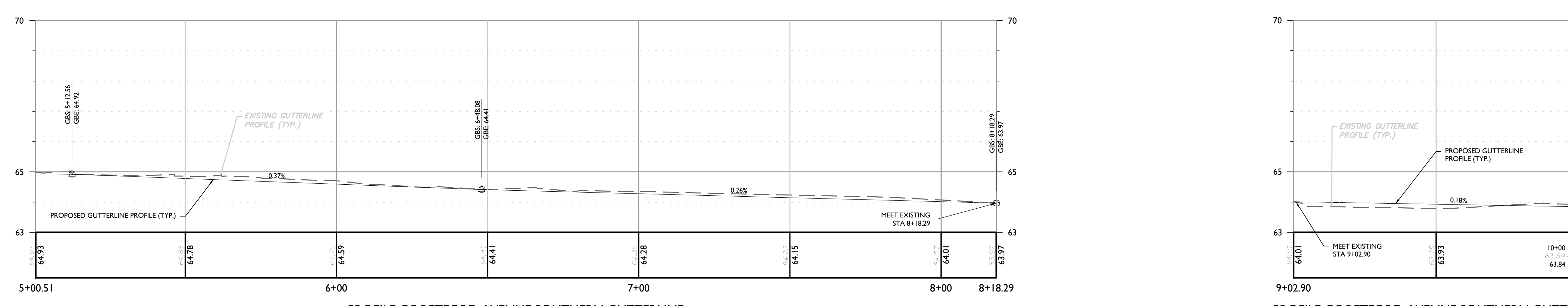

PROFILE OF RETFORD AVENUE SOUTHERN GUTTERLINE
HORIZONTAL : 1" = 20'
VERTICAL : 1" = 2'

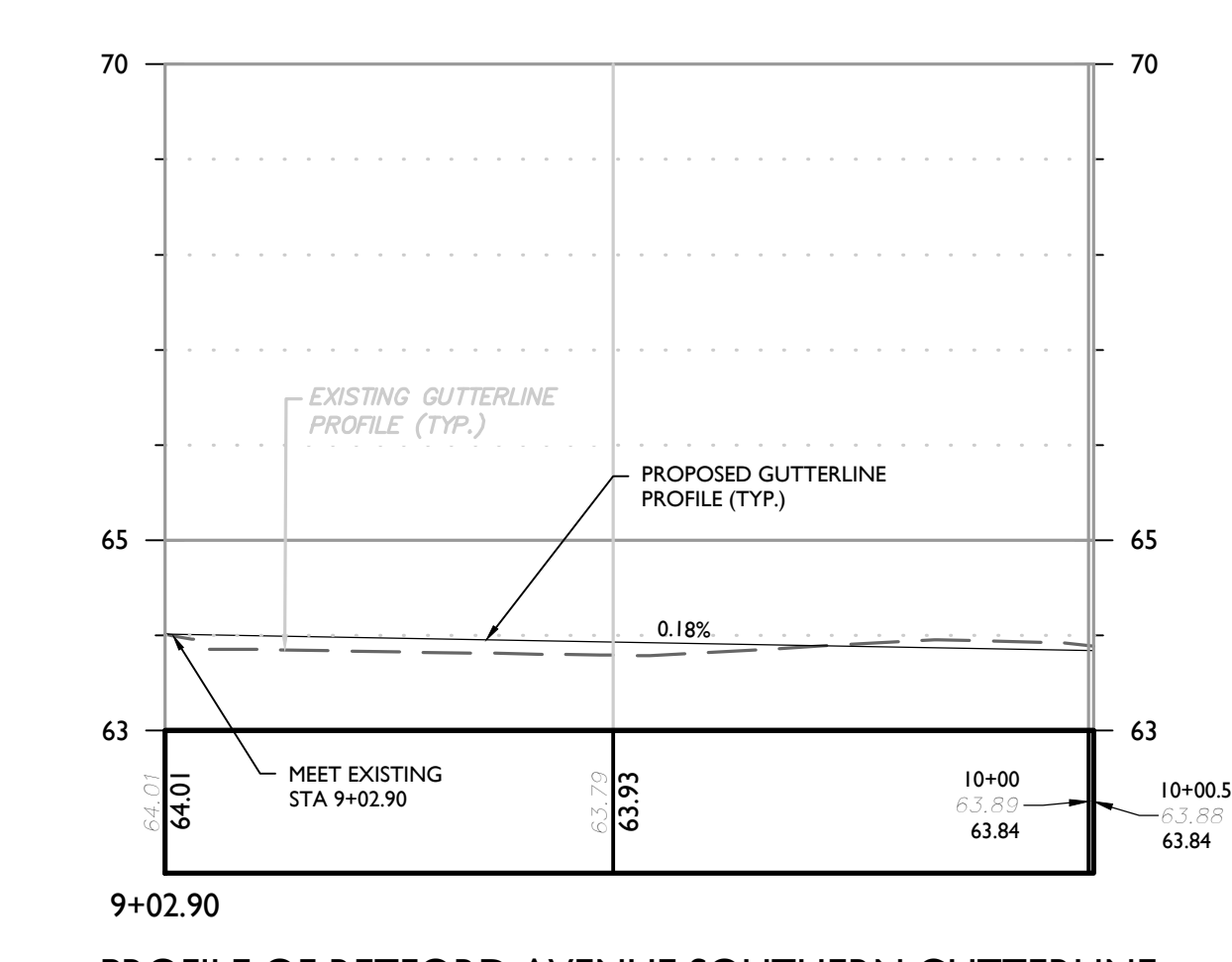

PROFILE OF RETFORD AVENUE SOUTHERN GUTTERLINE
HORIZONTAL : 1" = 20'
VERTICAL : 1" = 2'

NOTES:
1. THIS PROJECT IS EXEMPT FROM SOIL DE-COMPACTION REMEDIATION AND TESTING AS IT IS LOCATED IN AN URBAN REDEVELOPMENT AREA.

SOIL EROSION AND SEDIMENT CONTROL PLAN

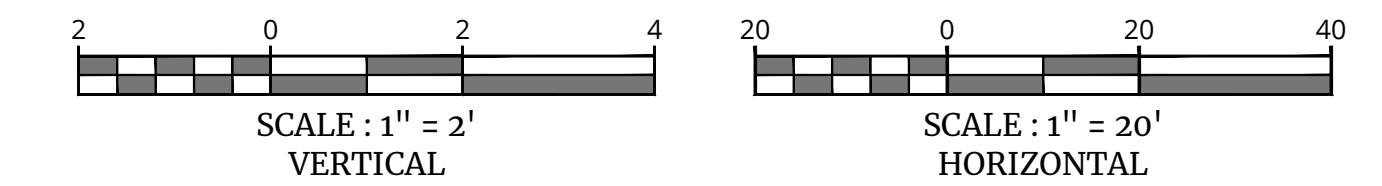

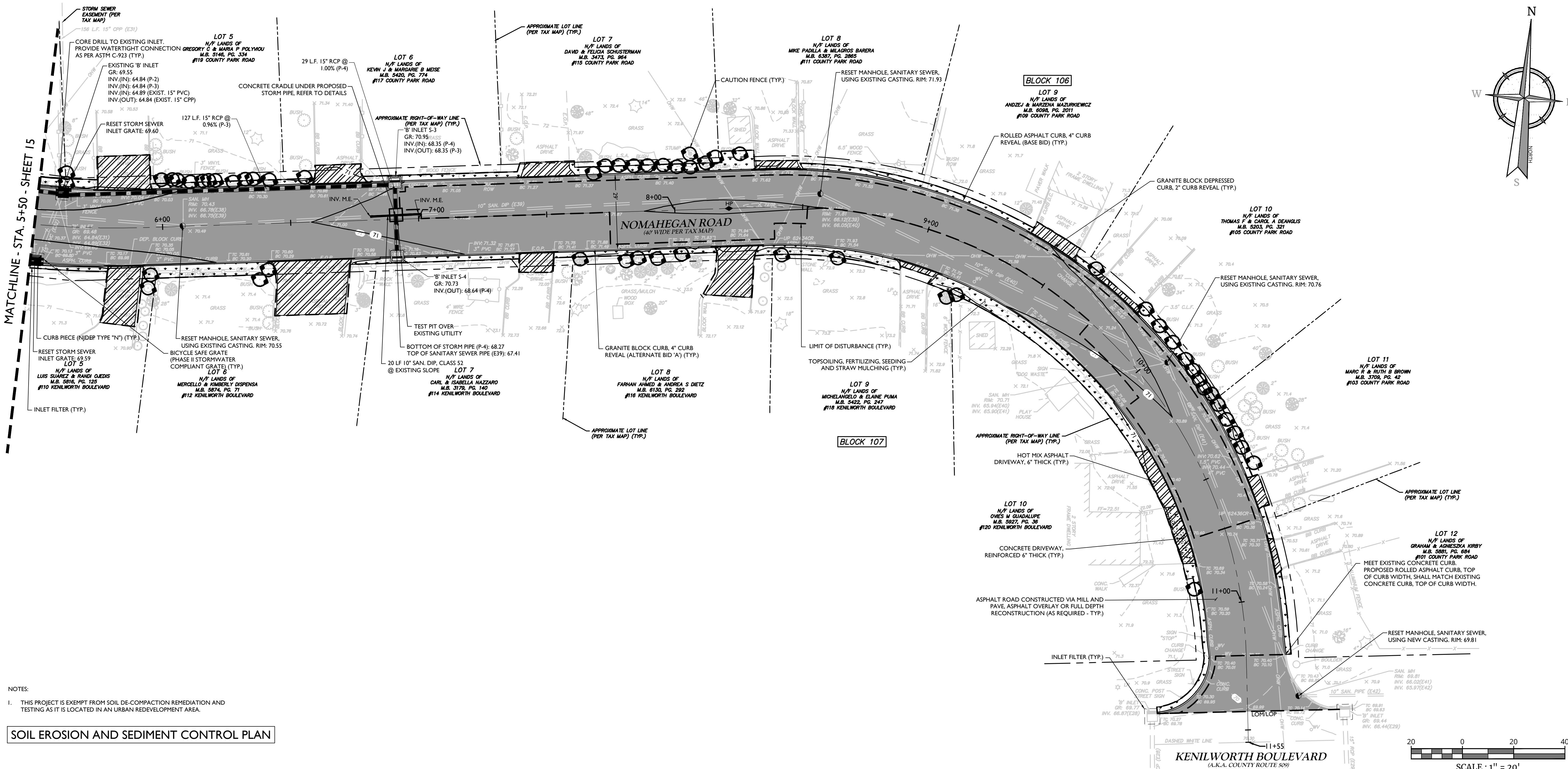
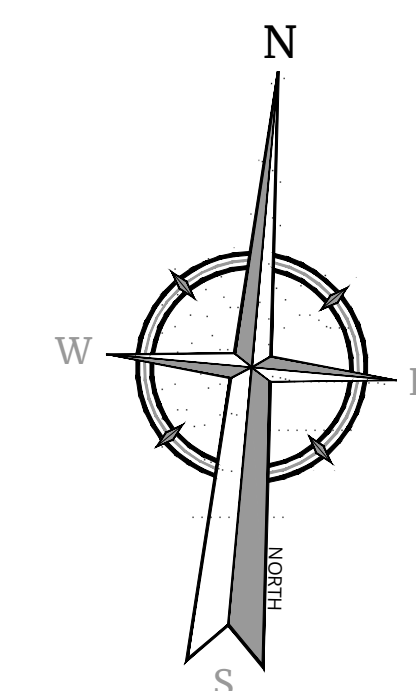

NOTES:
1. THIS PROJECT IS EXEMPT FROM SOIL DE-COMPACTION REMEDIATION AND TESTING AS IT IS LOCATED IN AN URBAN REDEVELOPMENT AREA.

SOIL EROSION AND SEDIMENT CONTROL PLAN

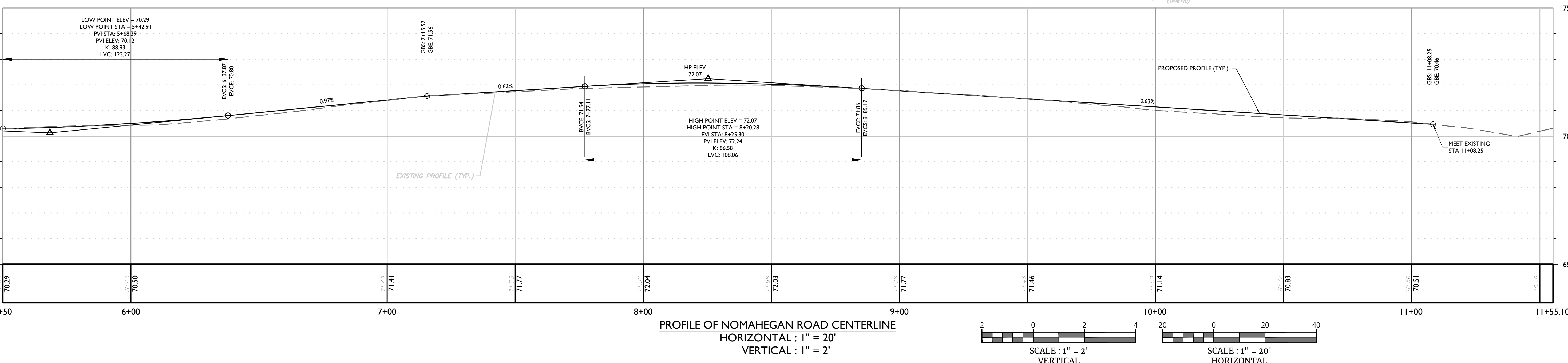

Table with columns: REV, DATE, DRAWN BY, DESCRIPTION. Contains revision history.

Carl P. O'Brien
NEW JERSEY LICENSED PROFESSIONAL ENGINEER
LICENSE NUMBER: 645154
COLLIERS ENGINEERING & DESIGN, INC.
N.J. C.O.A. #: 24GA27986500

CONSTRUCTION PLANS
FOR
2022 VARIOUS
DRAINAGE
IMPROVEMENTS
TOWNSHIP OF CRANFORD
COUNTY OF UNION
NEW JERSEY

Colliers Engineering & Design
MT. ARLINGTON
400 Valley Road,
Suite 304
Mt. Arlington, NJ 07856
Phone: 973.398.3110
COLLIERS ENGINEERING & DESIGN, INC.
DOING BUSINESS AS MASER CONSULTING

Table with columns: SCALE, DATE, DRAWN BY, CHECKED BY, PROJECT NUMBER, DRAWING NAME.

DIMENSION PLAN - NOMAHEGAN ROAD & NOMAHEGAN COURT

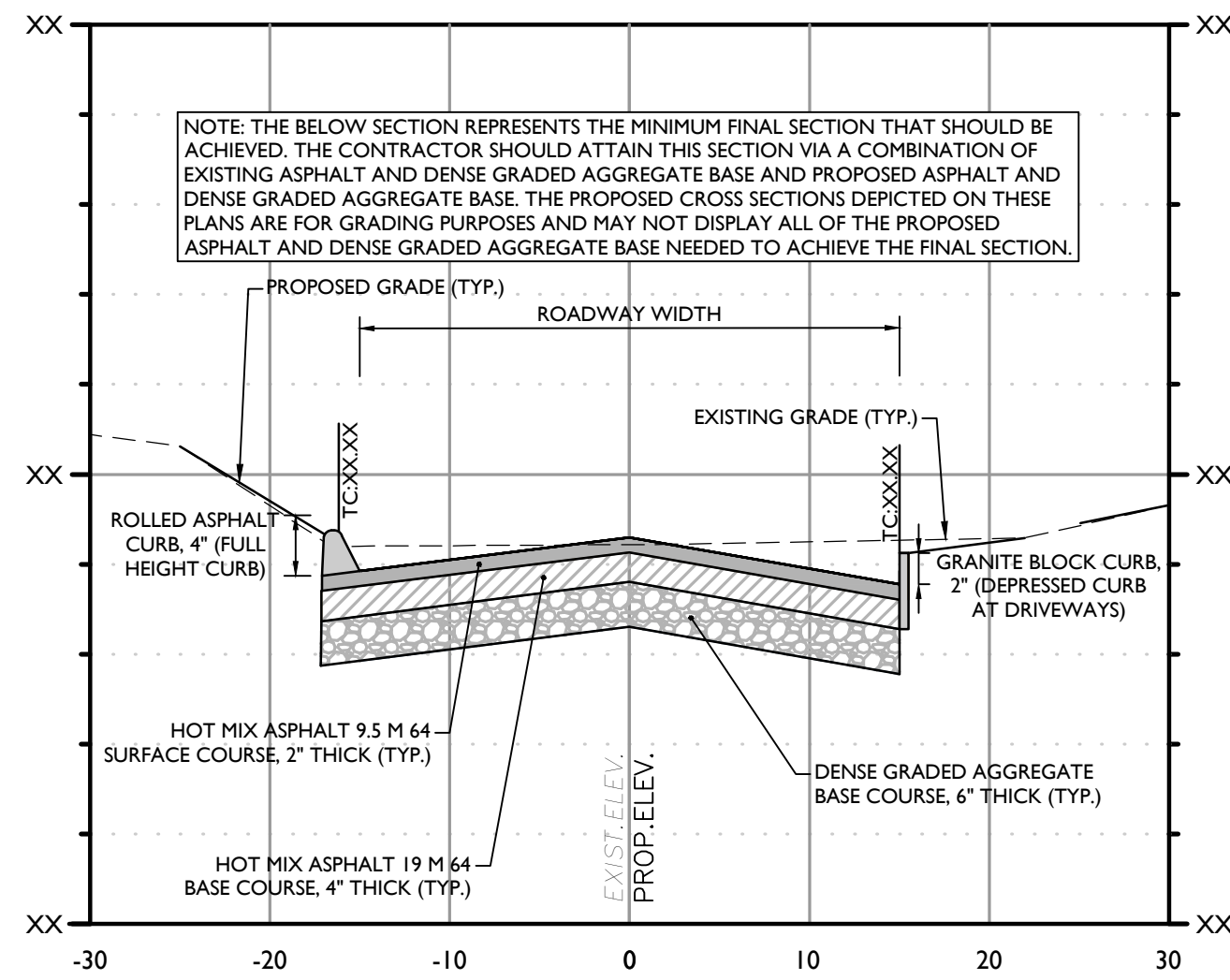

TYPICAL CROSS SECTION OF NOMAHEGAN ROAD
CENTERLINE ALIGNMENT
STATION: XX+XX.XX
HORIZONTAL : 1" = 10'
VERTICAL : 1" = 2'

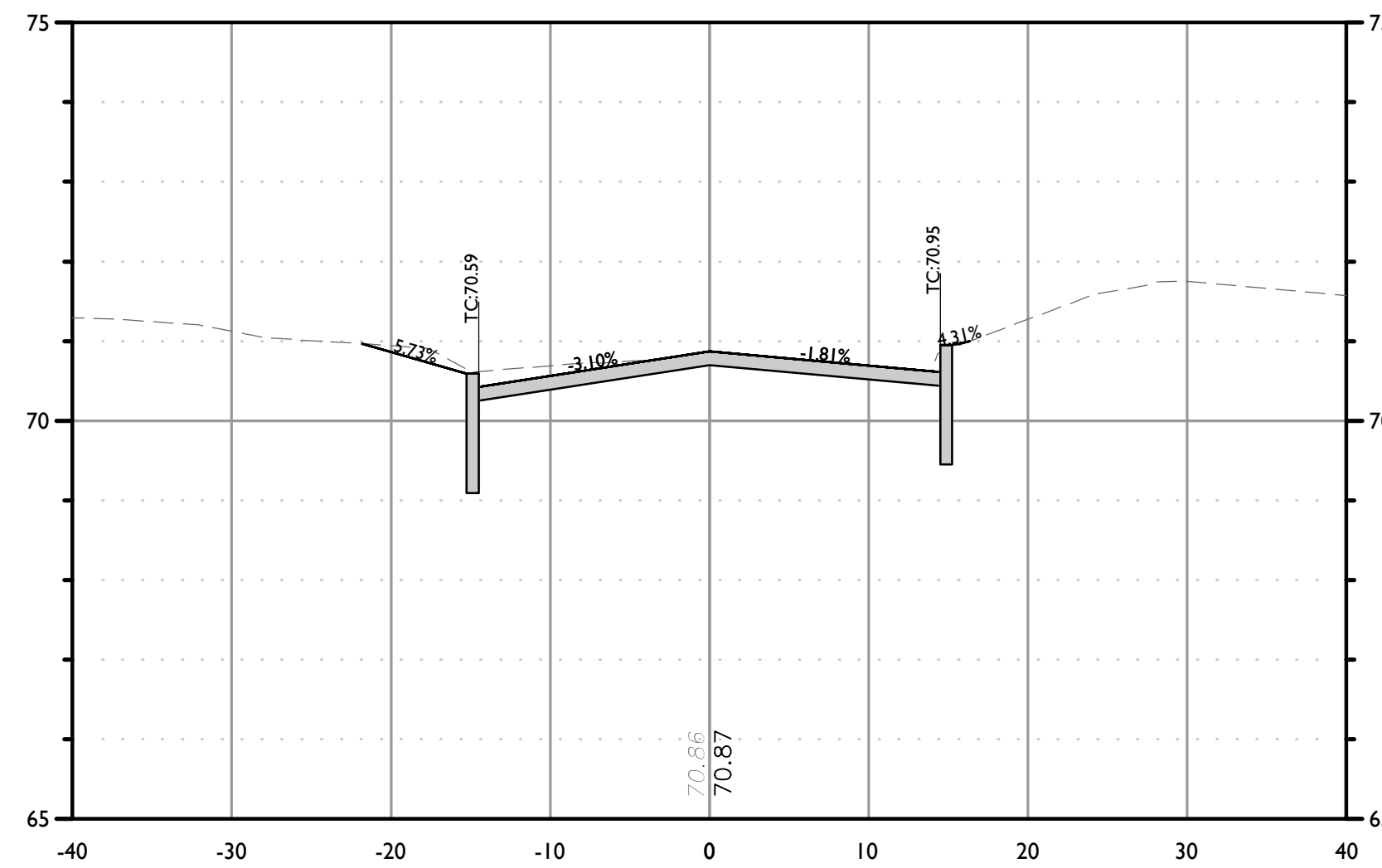

CROSS SECTION OF NOMAHEGAN ROAD CENTERLINE
STATION: 1+72.89
HORIZONTAL : 1" = 10'
VERTICAL : 1" = 2'

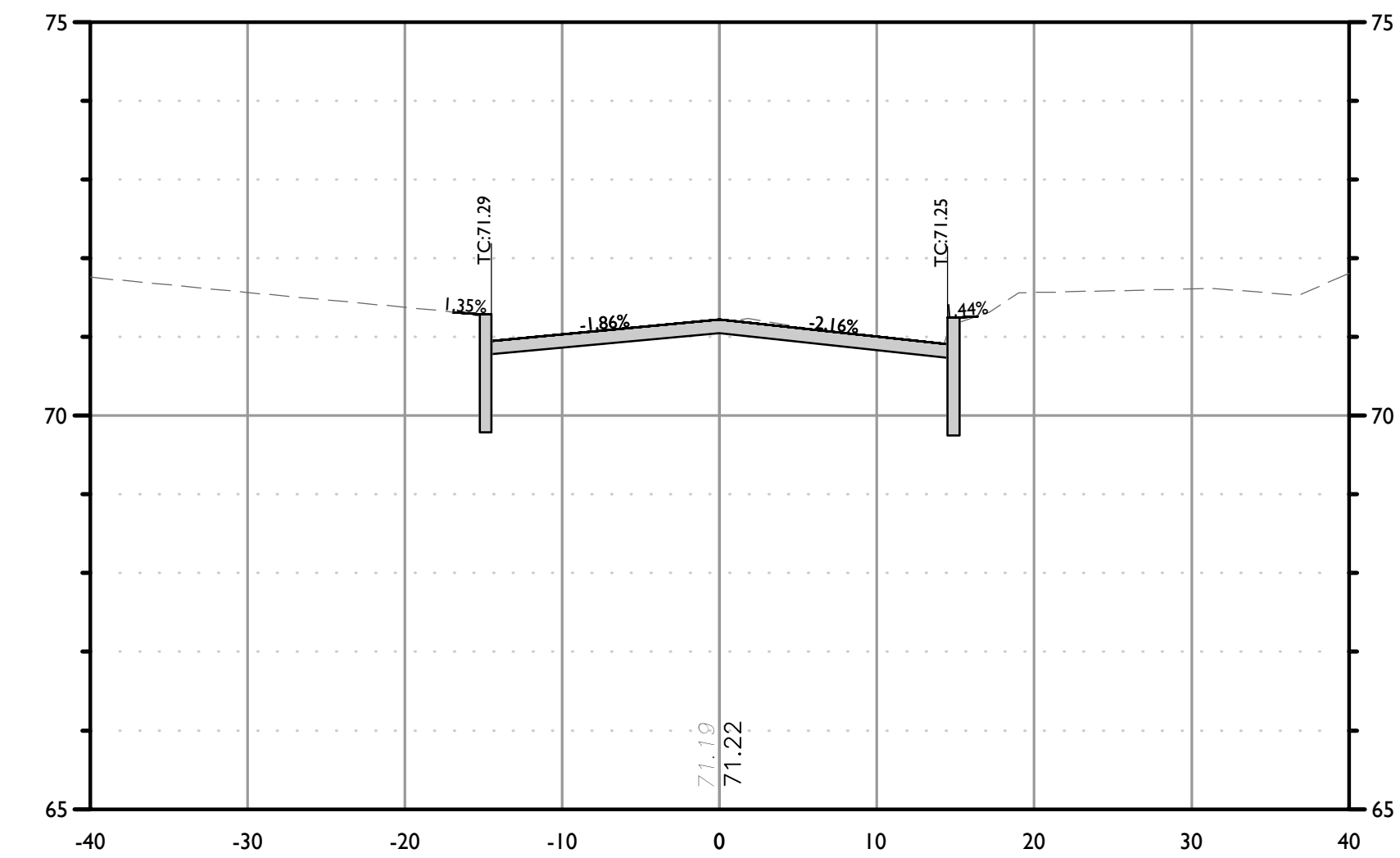

CROSS SECTION OF NOMAHEGAN ROAD CENTERLINE
STATION: 2+00
HORIZONTAL : 1" = 10'
VERTICAL : 1" = 2'

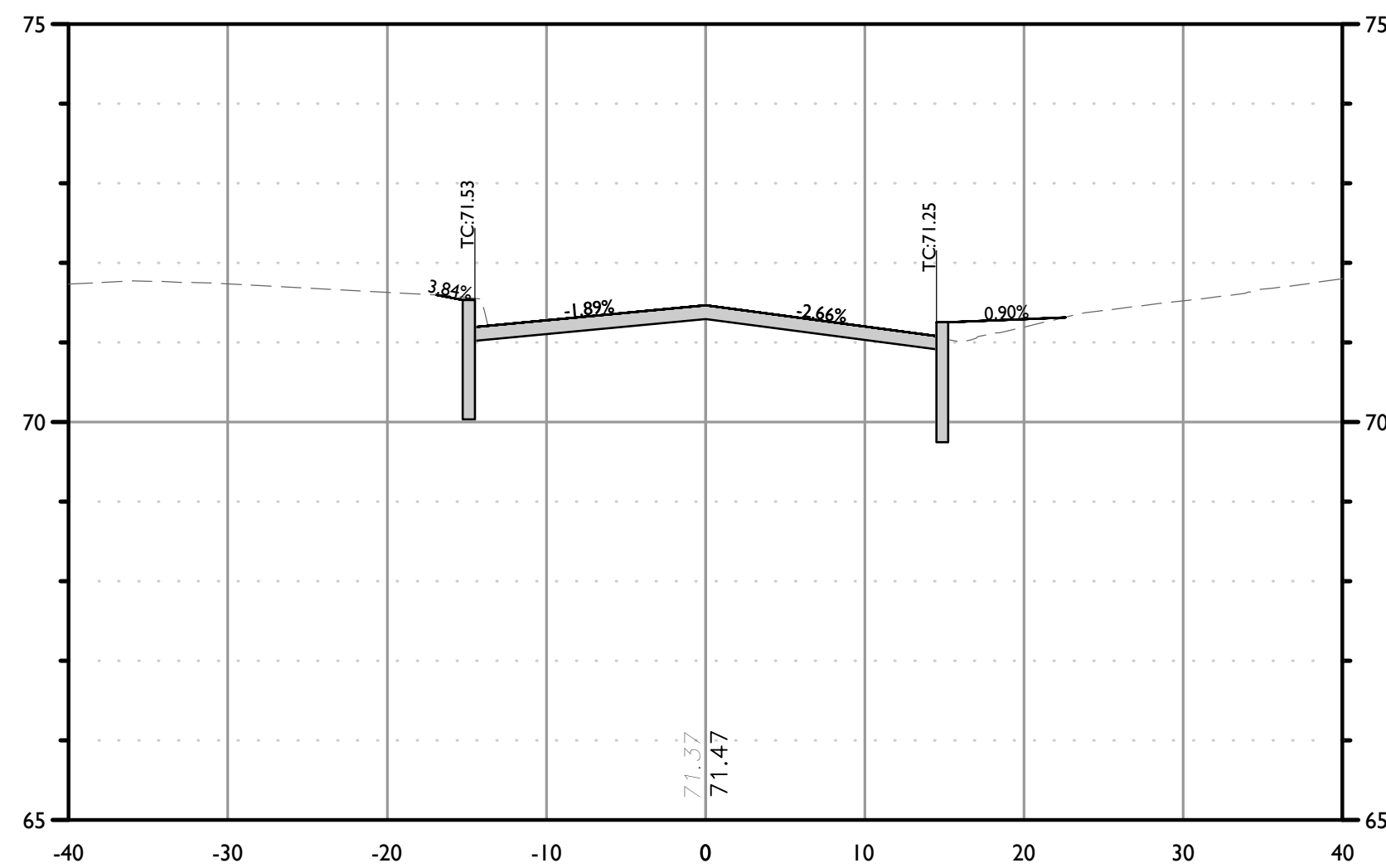

CROSS SECTION OF NOMAHEGAN ROAD CENTERLINE
STATION: 2+39.94
HORIZONTAL : 1" = 10'
VERTICAL : 1" = 2'

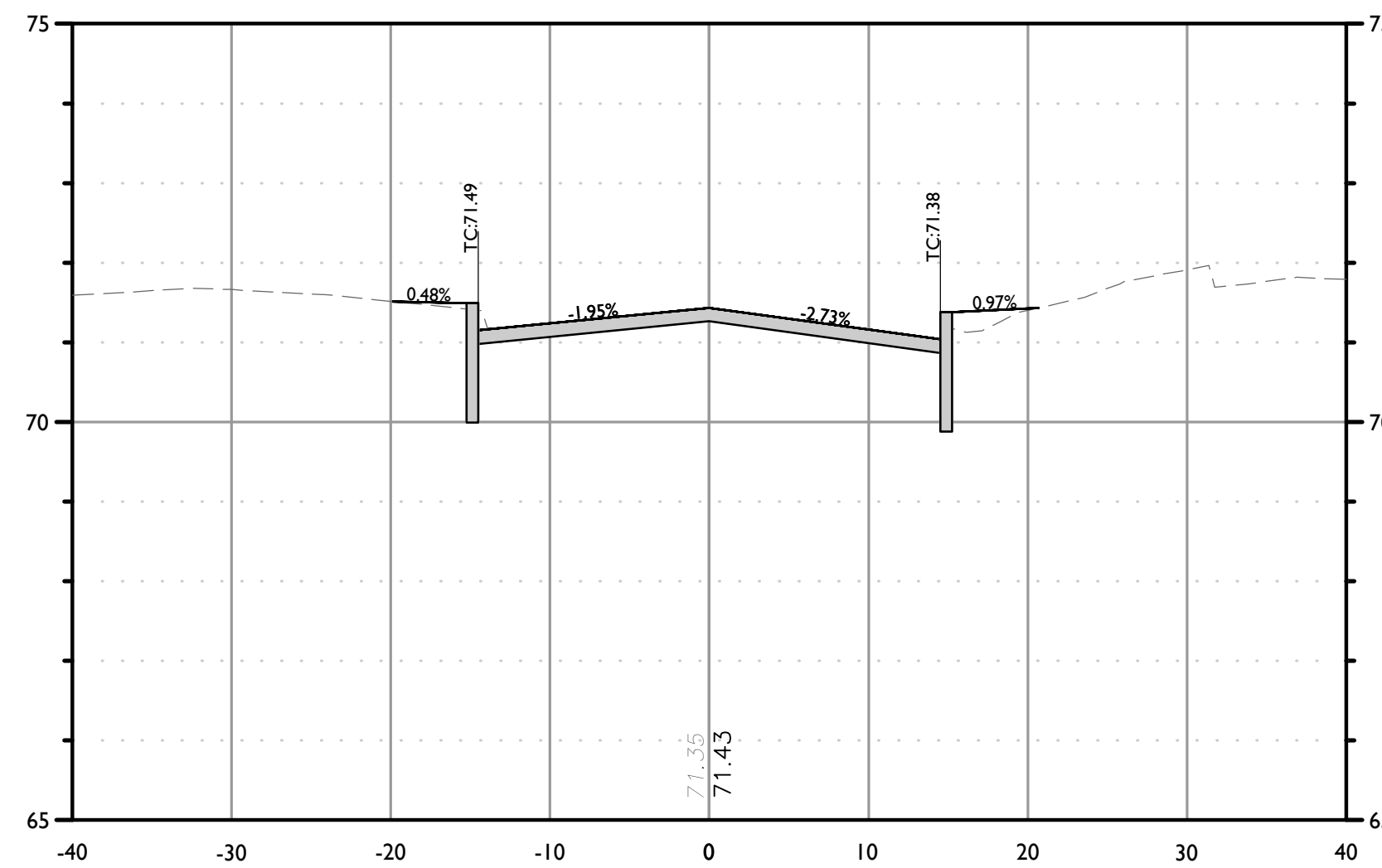

CROSS SECTION OF NOMAHEGAN ROAD CENTERLINE
STATION: 2+50
HORIZONTAL : 1" = 10'
VERTICAL : 1" = 2'

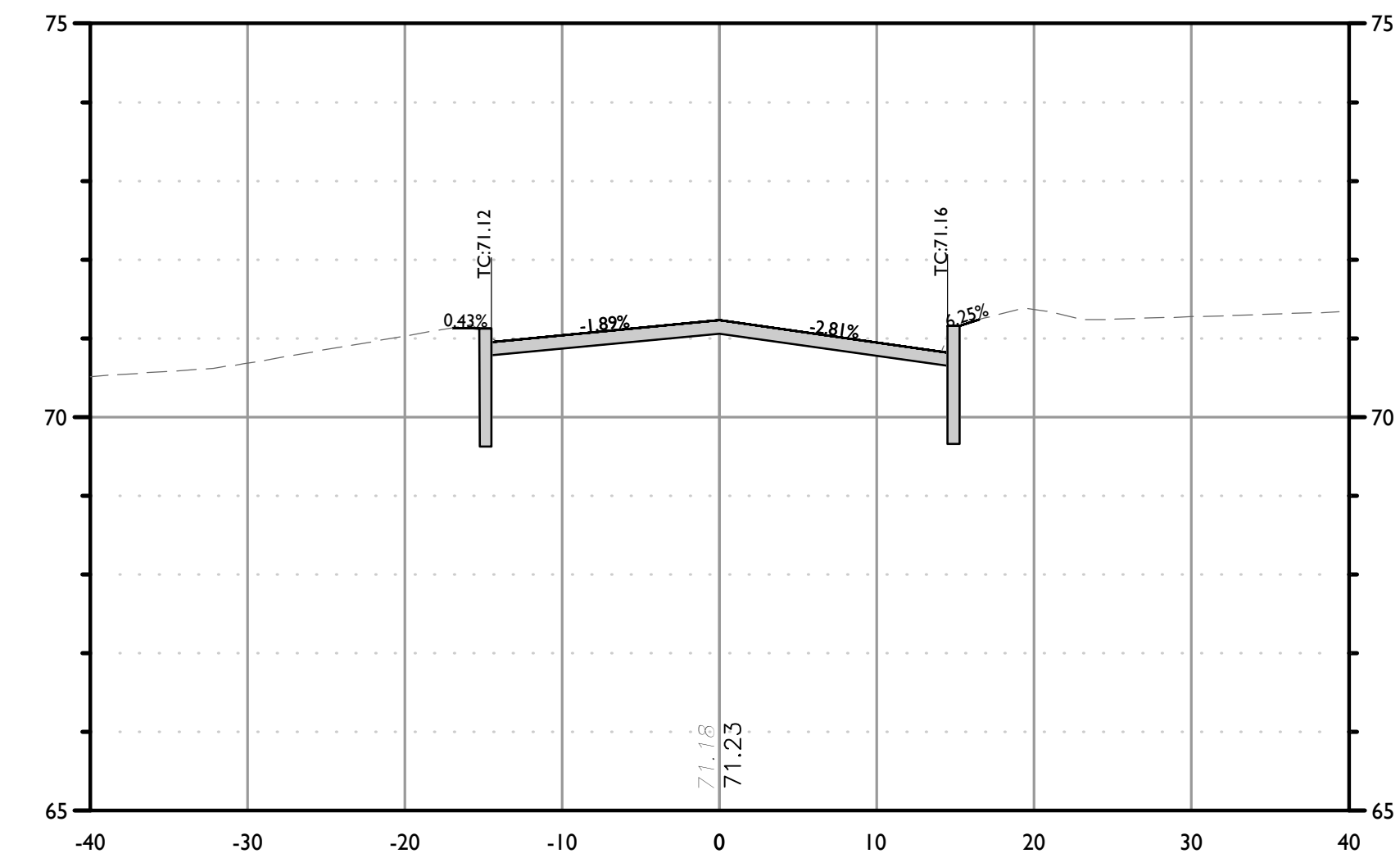

CROSS SECTION OF NOMAHEGAN ROAD CENTERLINE
STATION: 3+00
HORIZONTAL : 1" = 10'
VERTICAL : 1" = 2'

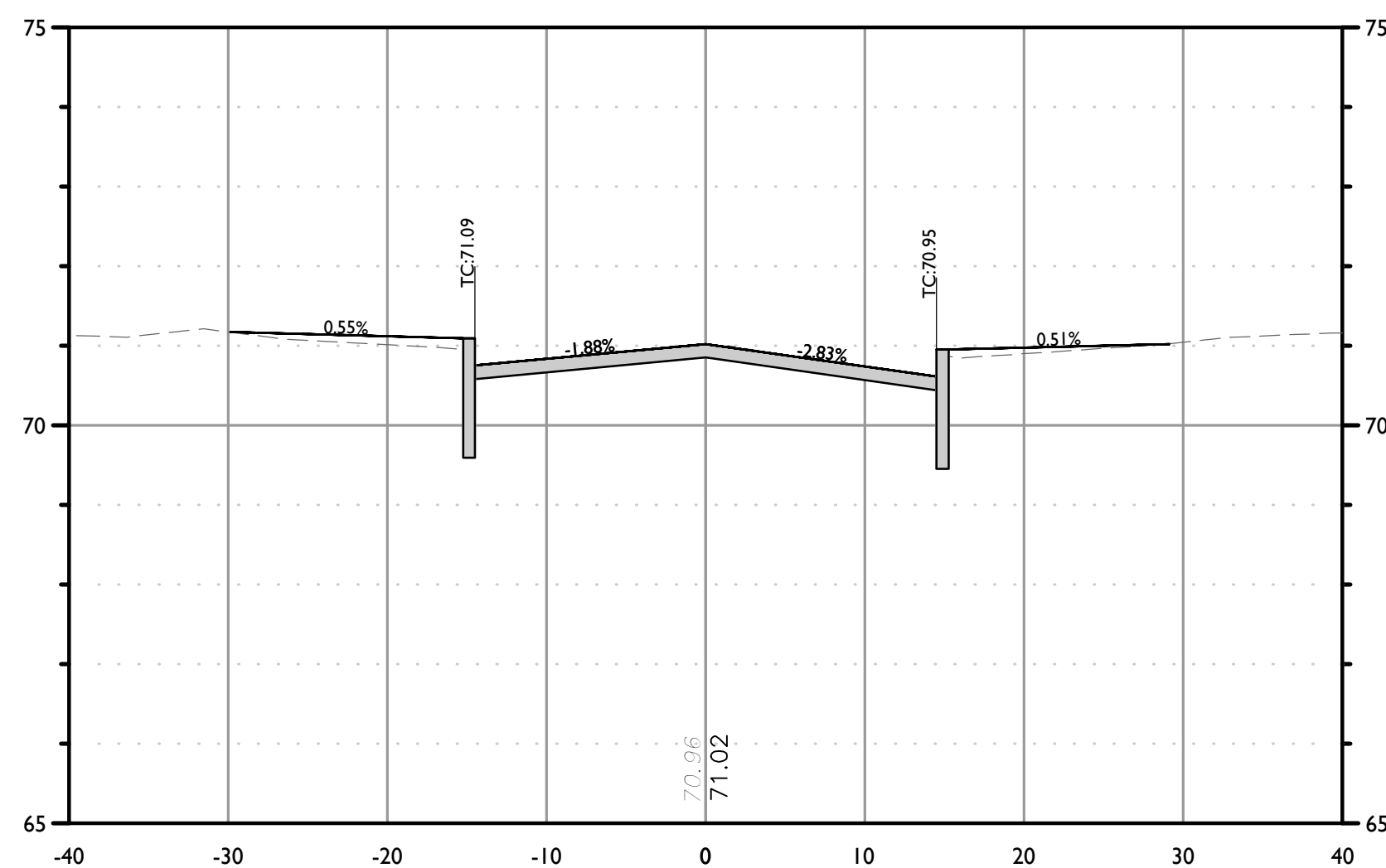

CROSS SECTION OF NOMAHEGAN ROAD CENTERLINE
STATION: 3+50
HORIZONTAL : 1" = 10'
VERTICAL : 1" = 2'

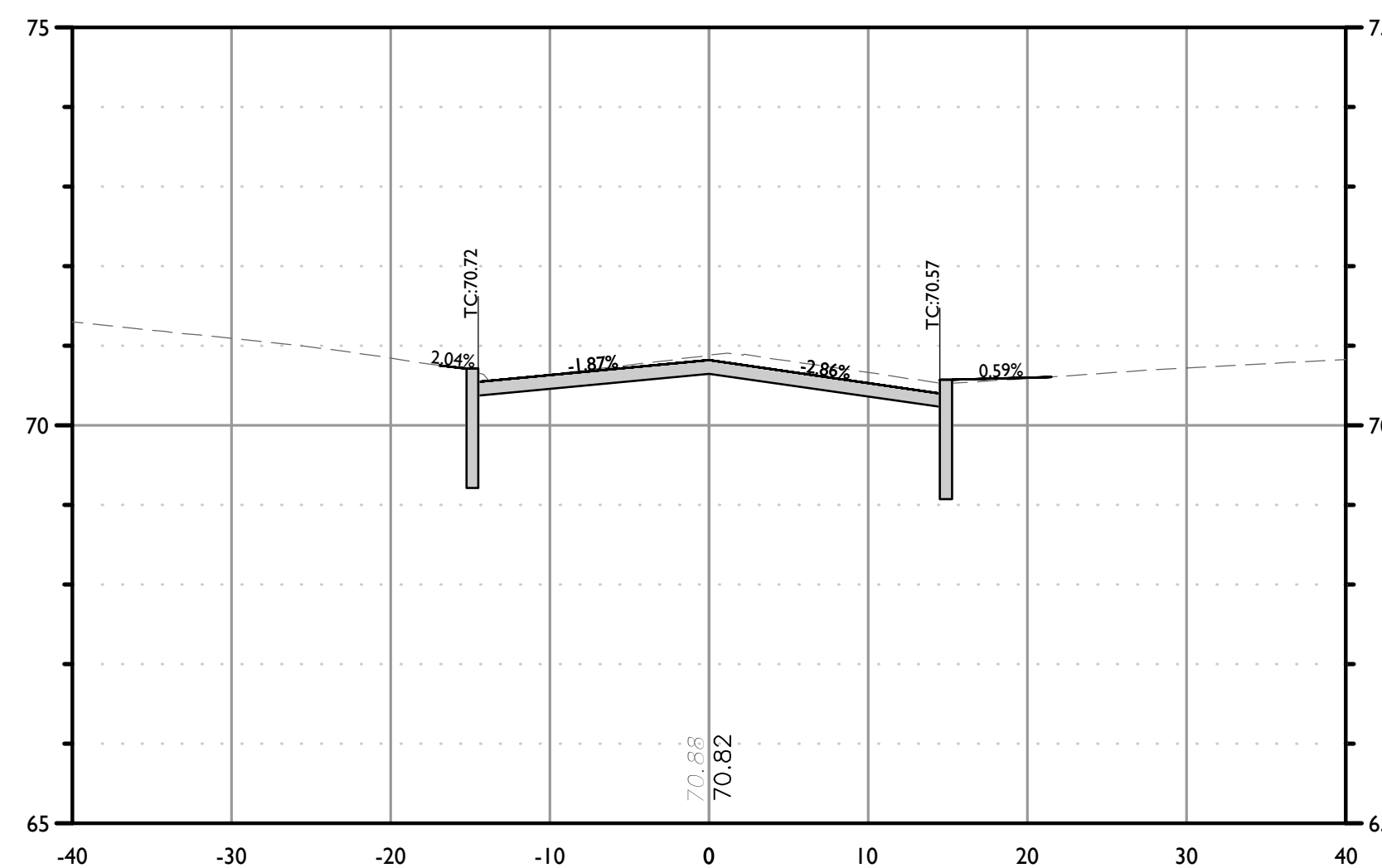

CROSS SECTION OF NOMAHEGAN ROAD CENTERLINE
STATION: 4+00
HORIZONTAL : 1" = 10'
VERTICAL : 1" = 2'

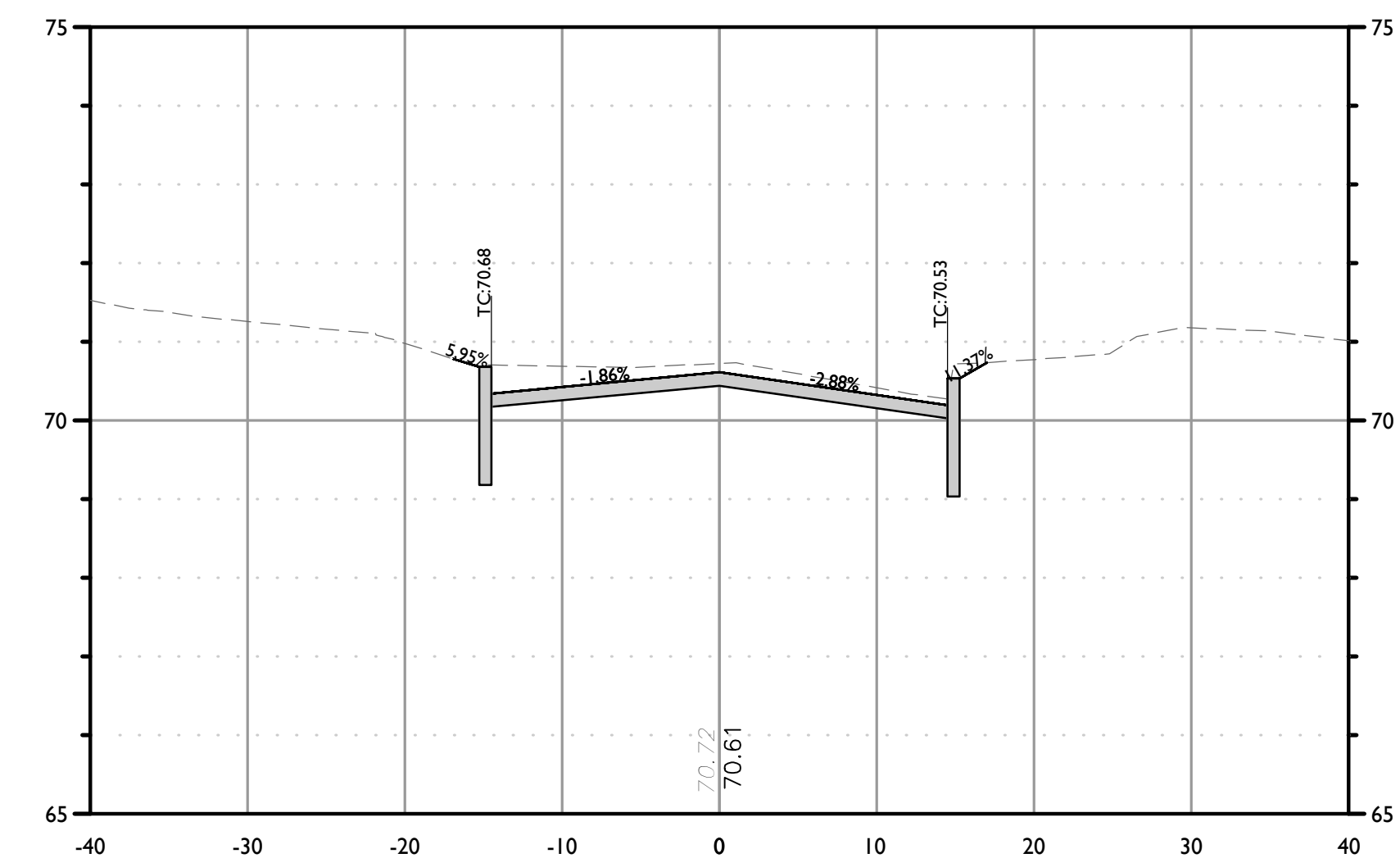

CROSS SECTION OF NOMAHEGAN ROAD CENTERLINE
STATION: 4+50
HORIZONTAL : 1" = 10'
VERTICAL : 1" = 2'

Colliers

Engineering & Design

www.colliersengineering.com

Copyright © 2022, Colliers Engineering & Design All Rights Reserved. This drawing and all the information contained herein is authorized for use only by the party for whom the services were contracted or to whom it is certified. This drawing may not be copied, revised, distributed or relied upon for any other purpose without the express written consent of Colliers Engineering & Design.

Doing Business as MASER CONSULTING

811 PROTECT YOURSELF
ALL STATES REQUIRE NOTIFICATION OF EXCAVATORS, DESIGNERS, OR ANY PERSON PREPARING TO DISTURB THE EARTH'S SURFACE ANYWHERE IN ANY STATE.
Know what's below.
Call before you dig.
FOR STATE SPECIFIC DIRECT PHONE NUMBERS VISIT: WWW.CALL811.COM

REV. DATE. DRAWN BY. DESCRIPTION.

Carl P. O'Brien
NEW JERSEY LICENSED PROFESSIONAL ENGINEER
LICENSE NUMBER: 6645154
COLLIERS ENGINEERING & DESIGN, INC.
N.J. C.O.A. #: 24GA27986500

CONSTRUCTION PLANS

FOR
2022 VARIOUS
DRAINAGE
IMPROVEMENTS

TOWNSHIP OF CRANFORD
COUNTY OF UNION
NEW JERSEY

Colliers Engineering & Design
MT. ARLINGTON
400 Valley Road,
Suite 304
Mt. Arlington, NJ 07856
Phone: 973.398.3110
COLLIERS ENGINEERING & DESIGN, INC.
DOING BUSINESS AS MASER CONSULTING

SCALE: AS SHOWN DATE: 09/23/2022 DRAWN BY: AP CHECKED BY: PC
PROJECT NUMBER: CDT0083 DRAWING NAME: C-LAY1-NOMA

CROSS SECTIONS -
NOMAHEGAN ROAD

SHEET NUMBER: 19 of 37

NOTE: DO NOT SCALE DRAWINGS FOR CONSTRUCTION.

C:\CDT0083\Engineering\Drawings\LAY1-NOMA.dwg, 15:45:00, 09/23/2022, BY: PCOLICHE

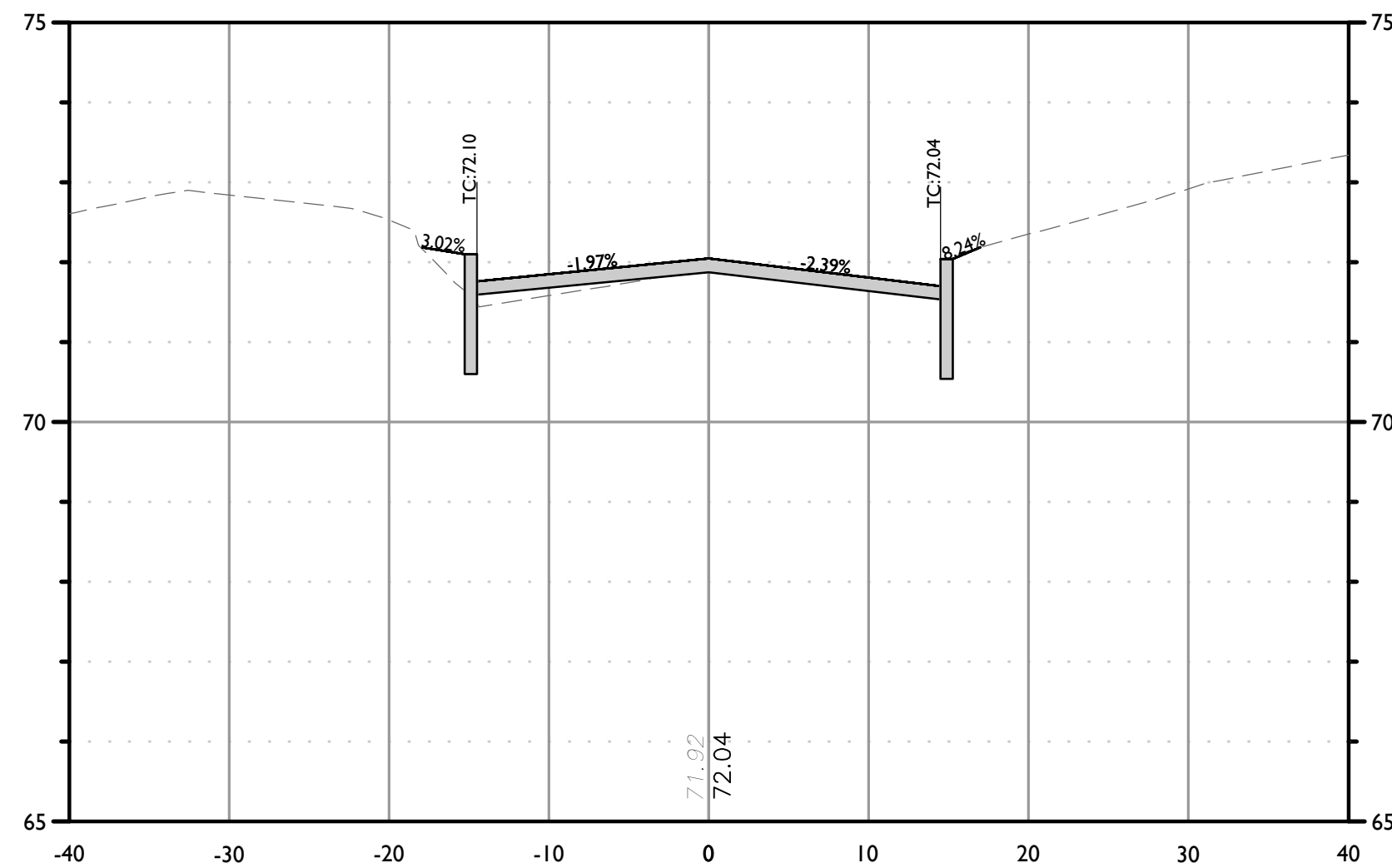

CROSS SECTION OF NOMAHEGAN ROAD CENTERLINE
 STATION: 8+00
 HORIZONTAL : 1" = 10'
 VERTICAL : 1" = 2'

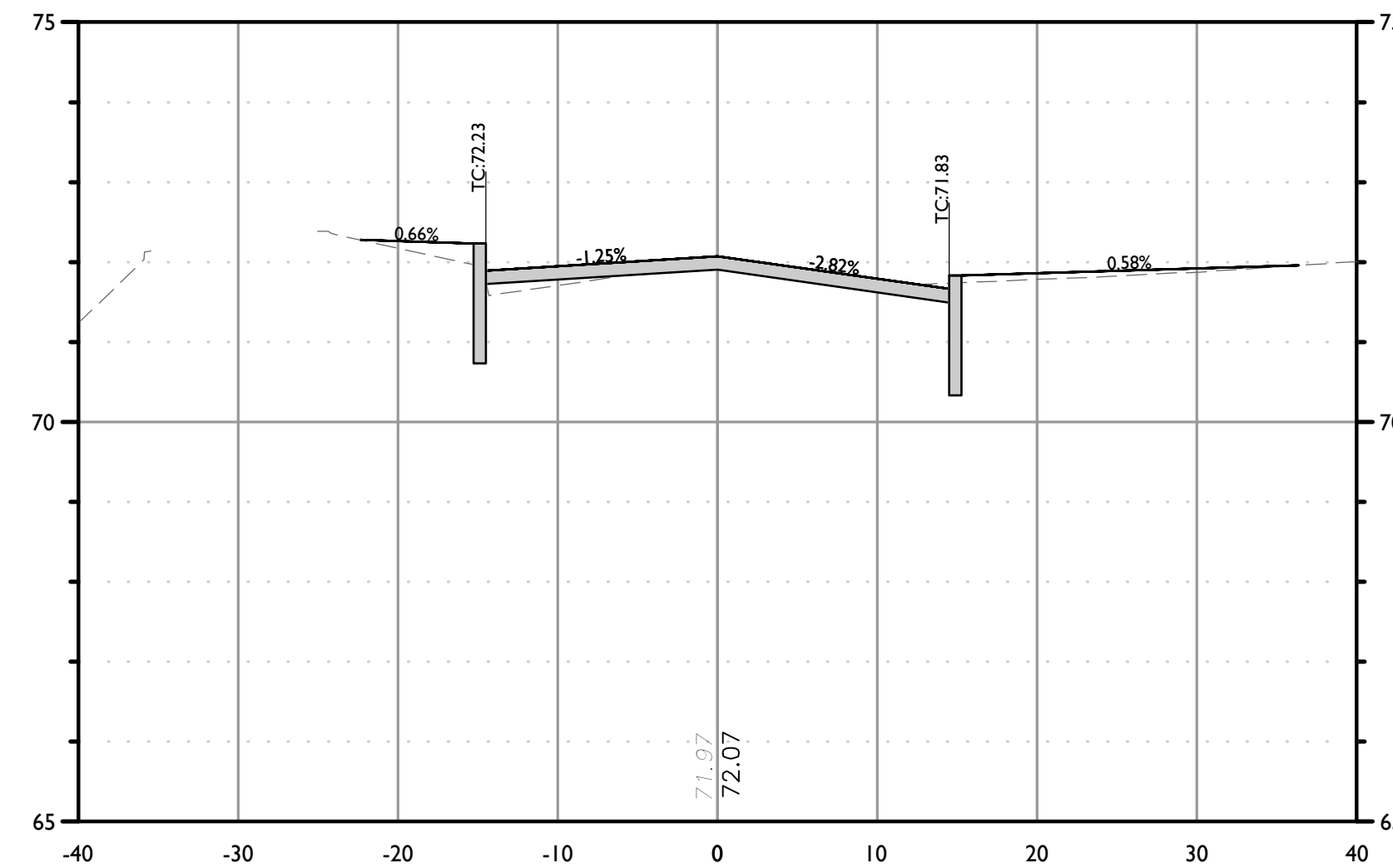

CROSS SECTION OF NOMAHEGAN ROAD CENTERLINE
 STATION: 8+23.07
 HORIZONTAL : 1" = 10'
 VERTICAL : 1" = 2'

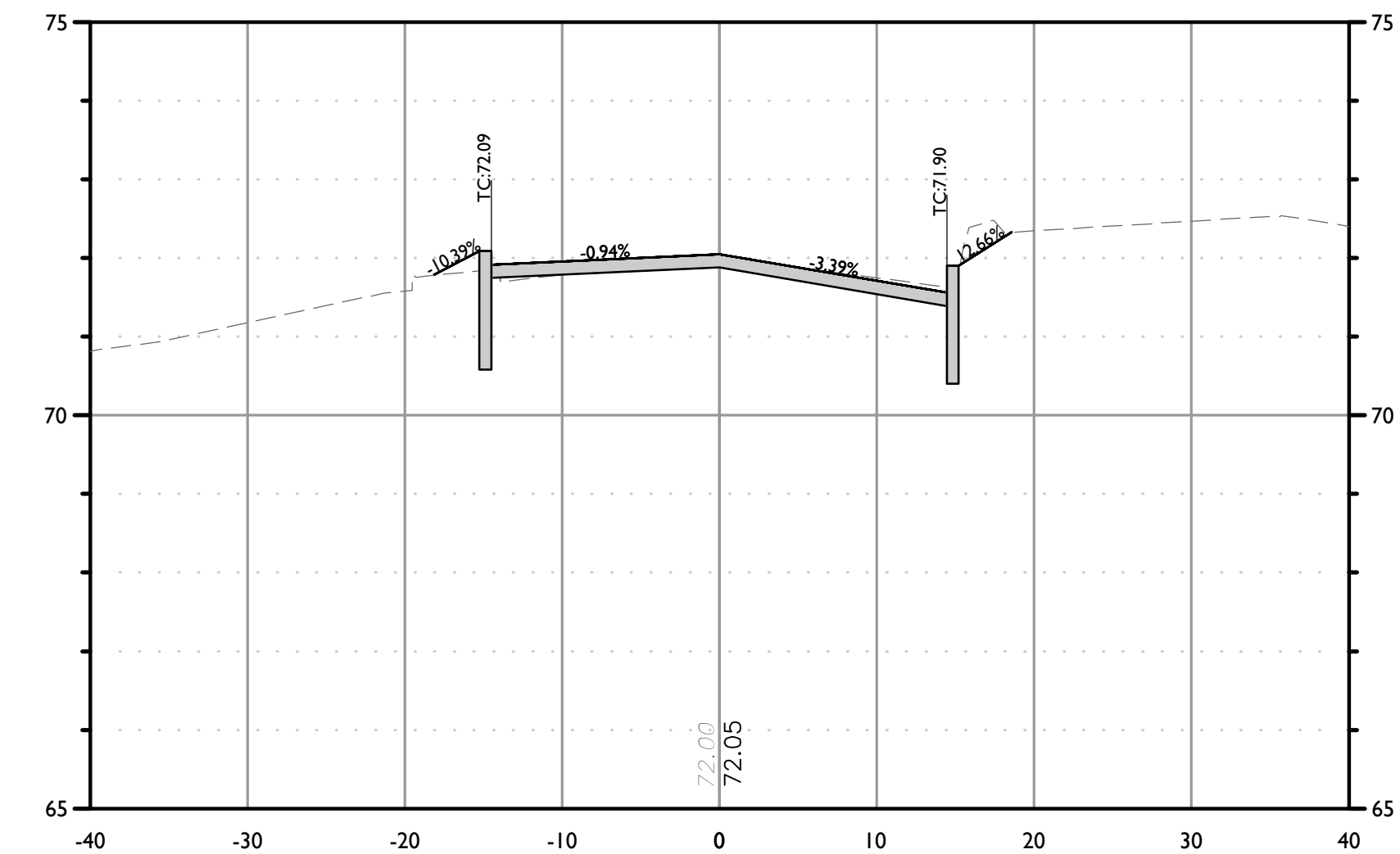

CROSS SECTION OF NOMAHEGAN ROAD CENTERLINE
 STATION: 8+40.54
 HORIZONTAL : 1" = 10'
 VERTICAL : 1" = 2'

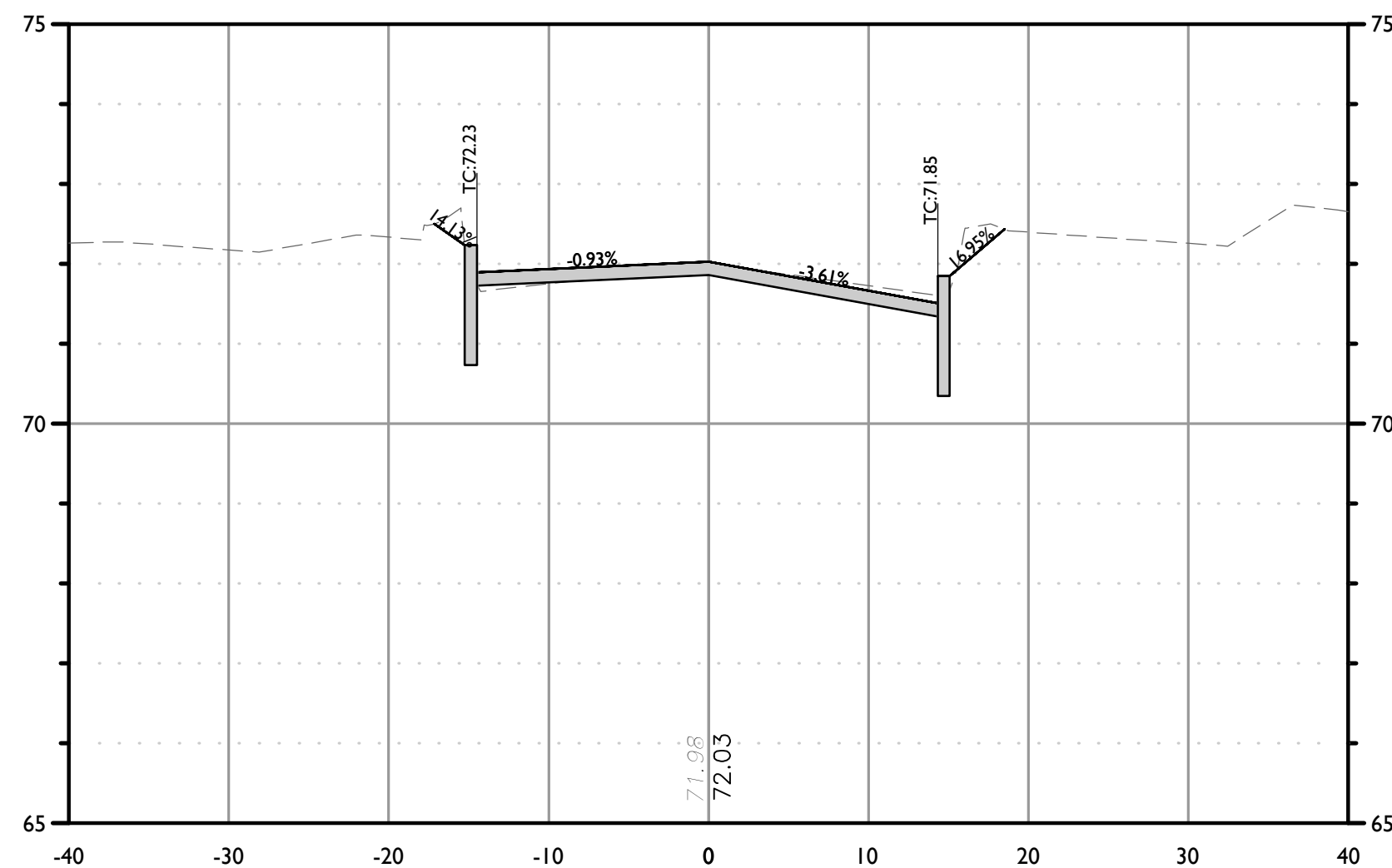

CROSS SECTION OF NOMAHEGAN ROAD CENTERLINE
 STATION: 8+50
 HORIZONTAL : 1" = 10'
 VERTICAL : 1" = 2'

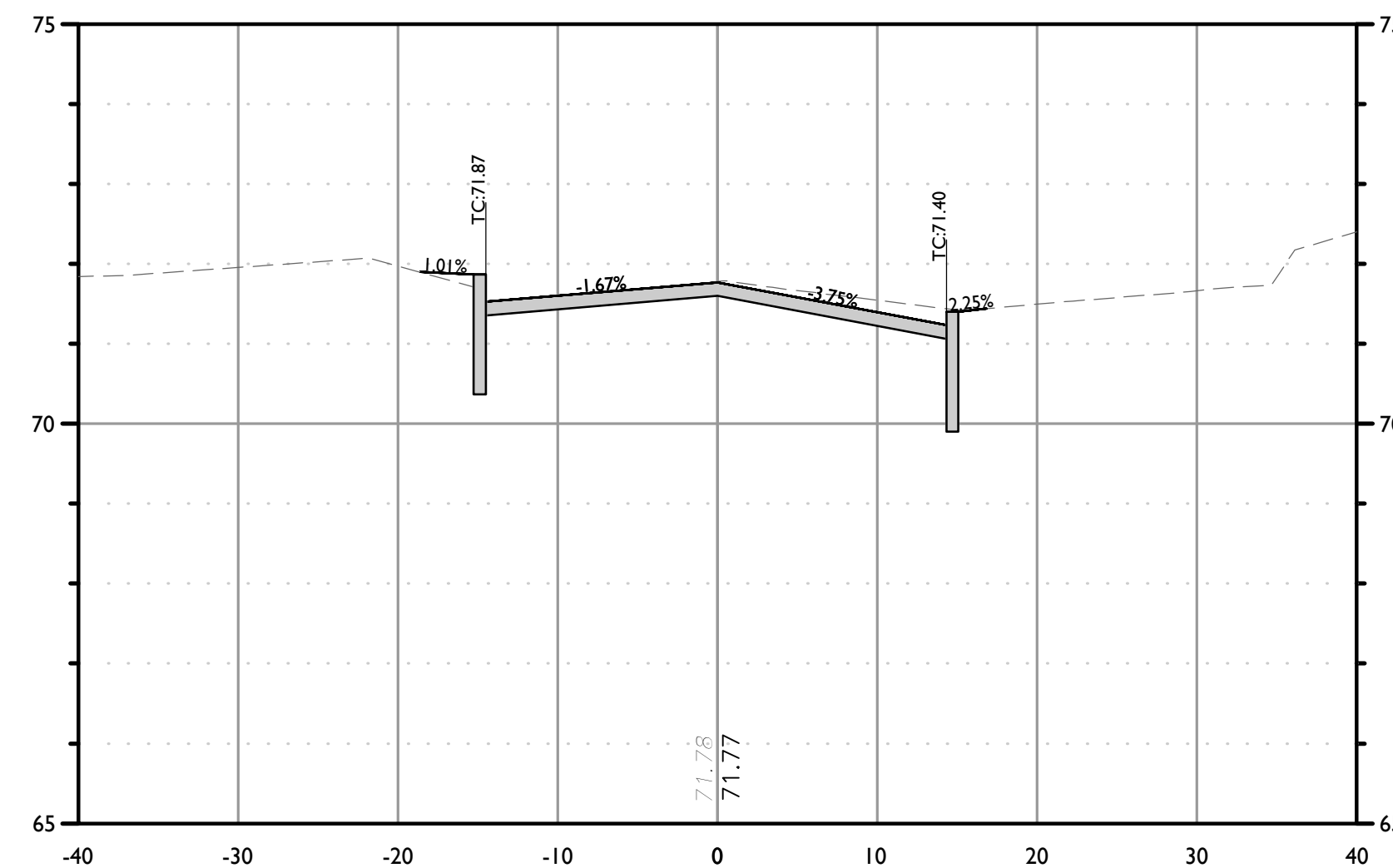

CROSS SECTION OF NOMAHEGAN ROAD CENTERLINE
 STATION: 9+00
 HORIZONTAL : 1" = 10'
 VERTICAL : 1" = 2'

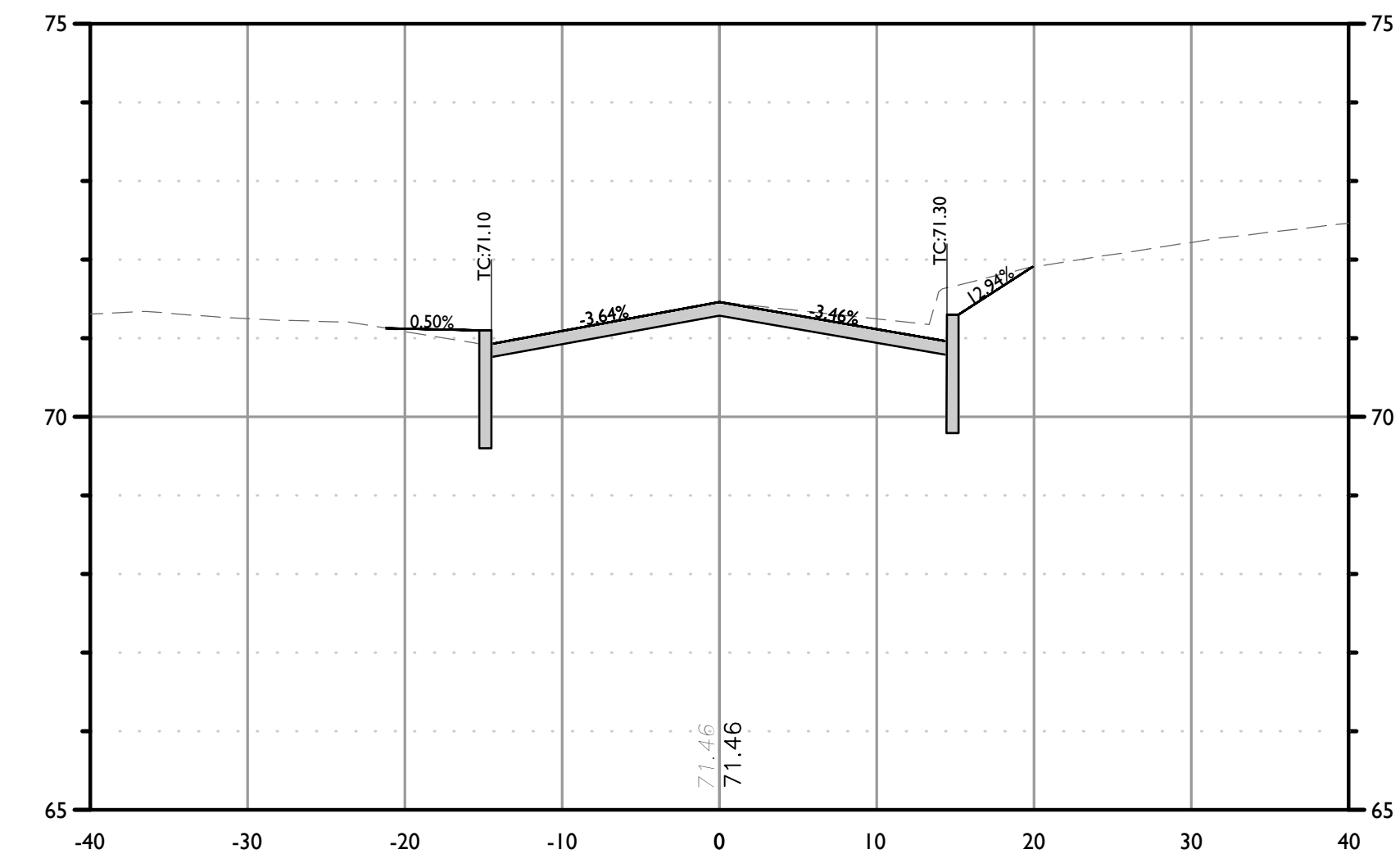

CROSS SECTION OF NOMAHEGAN ROAD CENTERLINE
 STATION: 9+50
 HORIZONTAL : 1" = 10'
 VERTICAL : 1" = 2'

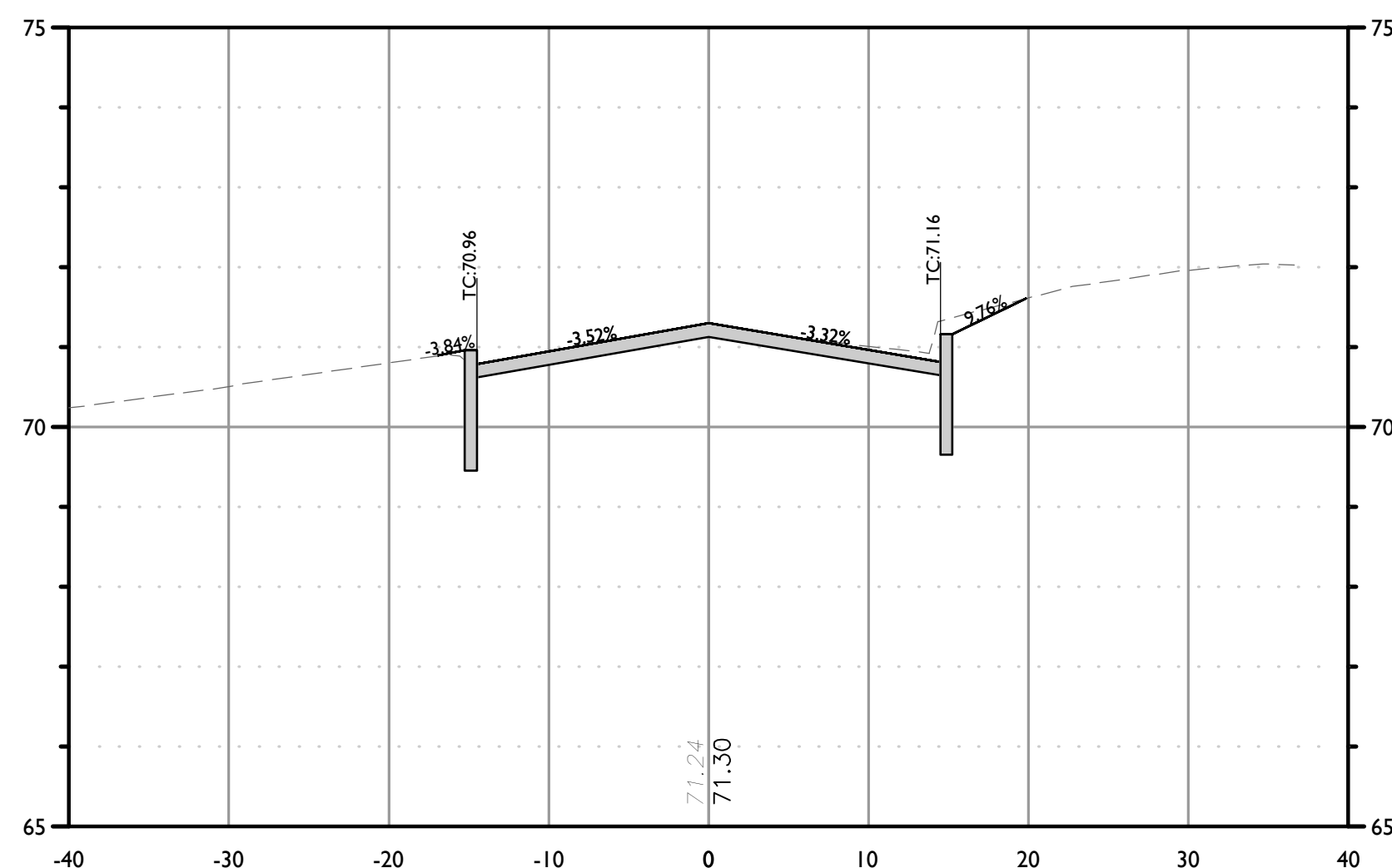

CROSS SECTION OF NOMAHEGAN ROAD CENTERLINE
 STATION: 9+75.07
 HORIZONTAL : 1" = 10'
 VERTICAL : 1" = 2'

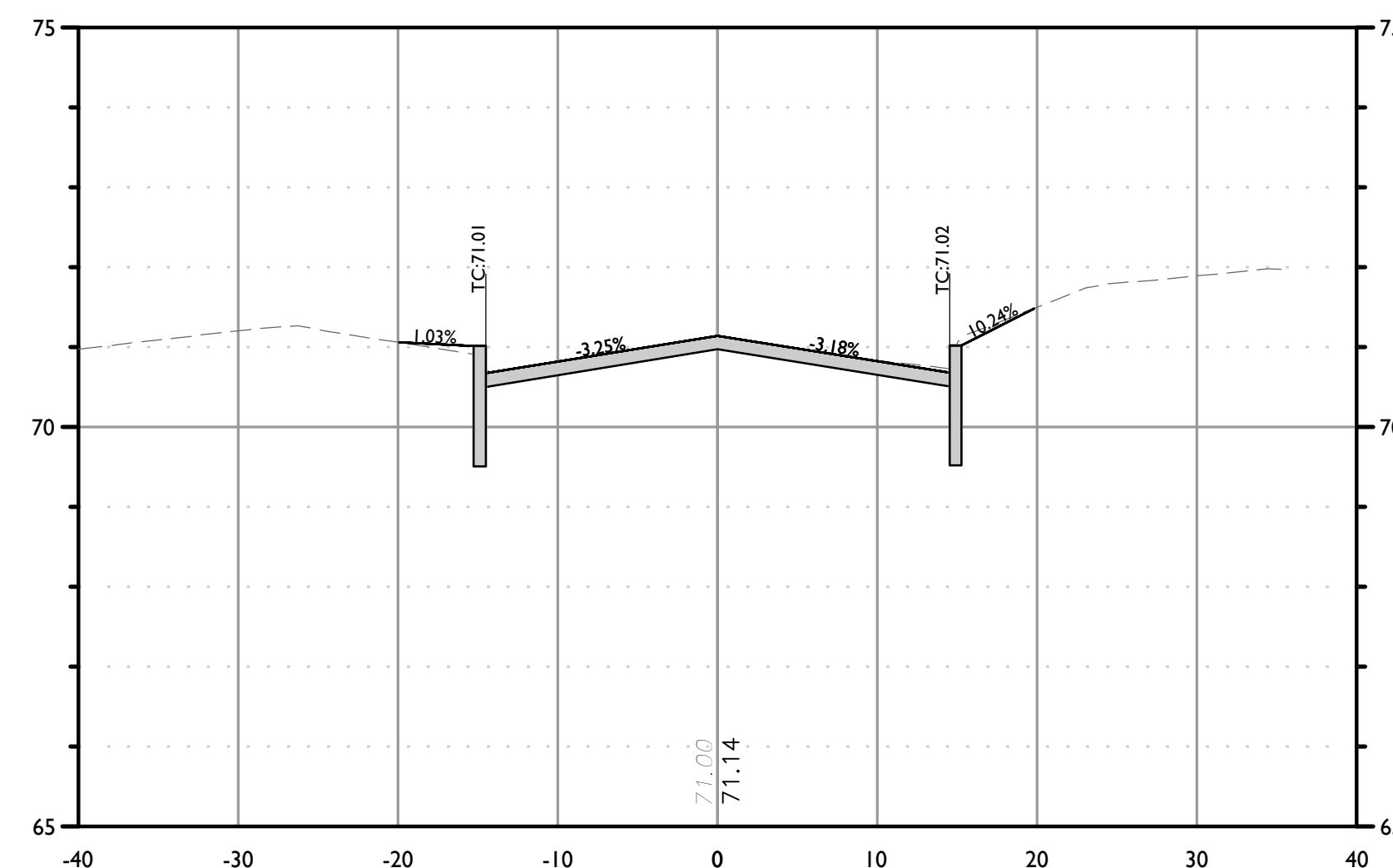

CROSS SECTION OF NOMAHEGAN ROAD CENTERLINE
 STATION: 10+00
 HORIZONTAL : 1" = 10'
 VERTICAL : 1" = 2'

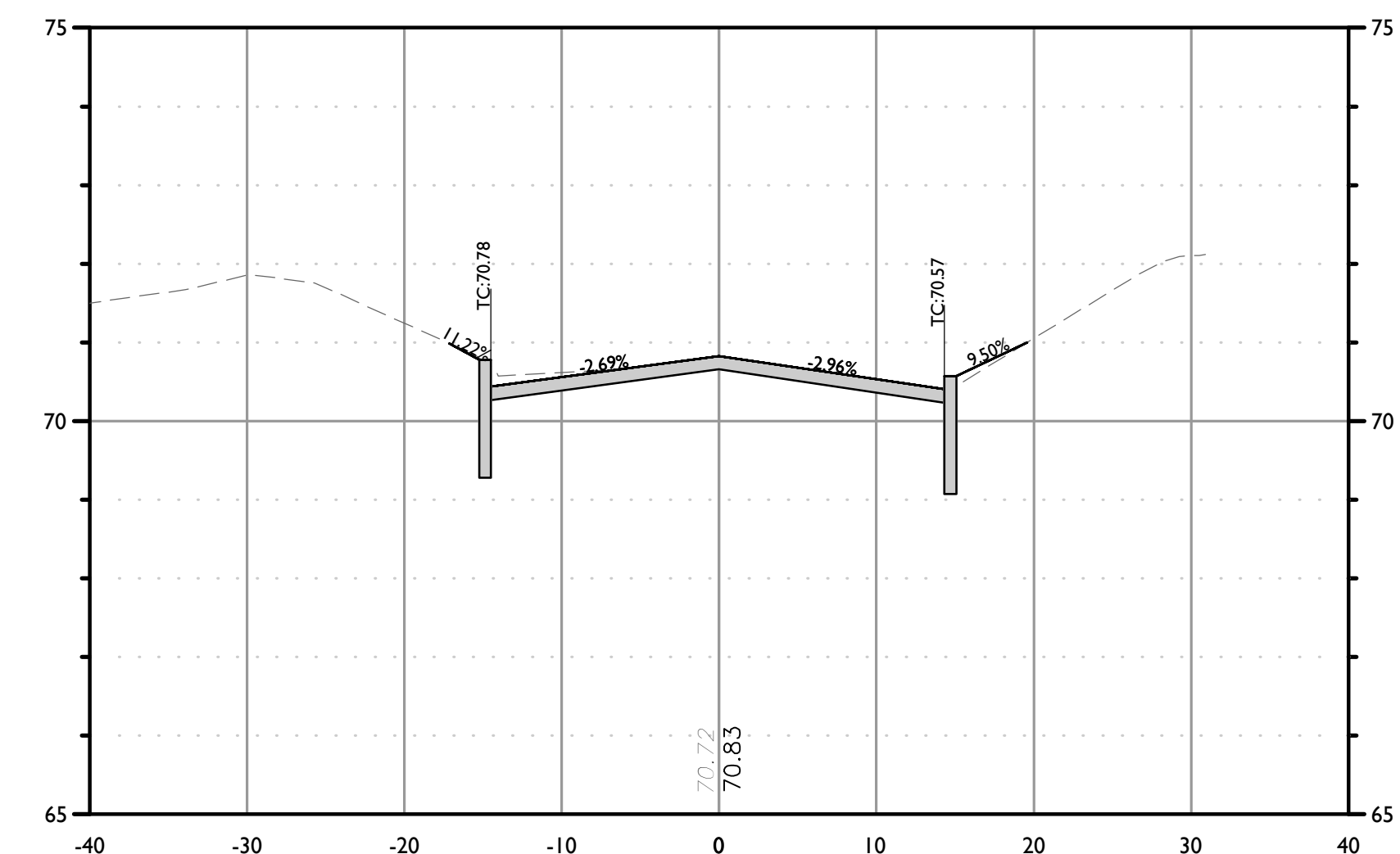

CROSS SECTION OF NOMAHEGAN ROAD CENTERLINE
 STATION: 10+50
 HORIZONTAL : 1" = 10'
 VERTICAL : 1" = 2'

Colliers

Engineering & Design

www.colliersengineering.com

Copyright © 2022, Colliers Engineering & Design All Rights Reserved. This drawing and all the information contained herein is authorized for use only by the party for whom the services were contracted or to whom it is certified. This drawing may not be copied, revised, disclosed, distributed or relied upon for any other purpose without the express written consent of Colliers Engineering & Design.

Doing Business as MASER CONSULTING

811 PROTECT YOURSELF
 ALL STATES REQUIRE NOTIFICATION OF EXCAVATORS, DESIGNERS, OR ANY PERSON PREPARING TO DISTURB THE EARTH'S SURFACE ANYWHERE IN ANY STATE
 Know what's below. Call before you dig.
 FOR STATE SPECIFIC DIRECT PHONE NUMBERS VISIT: WWW.CALL811.COM

REV	DATE	DRAWN BY	DESCRIPTION

Carl P. O'Brien

Carl P. O'Brien
 NEW JERSEY LICENSED PROFESSIONAL ENGINEER
 LICENSE NUMBER: 6645154
 COLLIERS ENGINEERING & DESIGN, INC.
 N.J. C.O.A. #: 24GA27986500

CONSTRUCTION PLANS

FOR
 2022 VARIOUS
 DRAINAGE
 IMPROVEMENTS

TOWNSHIP OF CRANFORD
 COUNTY OF UNION
 NEW JERSEY

Colliers
 Engineering & Design
 MT. ARLINGTON
 400 Valley Road,
 Suite 304
 Mt. Arlington, NJ 07856
 Phone: 973.398.3110
 COLLIERS ENGINEERING & DESIGN, INC.
 DOING BUSINESS AS MASER CONSULTING

SCALE: AS SHOWN DATE: 09/23/2022 DRAWN BY: AP CHECKED BY: PC
 PROJECT NUMBER: CDT0083 DRAWING NAME: C-LAY1-NOMA













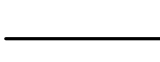
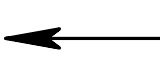

CROSS SECTIONS -
 NOMAHEGAN ROAD

SHEET NUMBER:
 21 of 37

NOTE: DO NOT SCALE DRAWINGS FOR CONSTRUCTION.

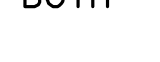
C:\CDT0083\Engineering\Drawings\LAY1-NOMA.dwg, 21: ASCE-NOMA, BY: PCOLICHE

LEGEND

-  BREAKAWAY BARRICADES
-  BREAKAWAY BARRICADES WITH SIGN
-  CONSTRUCTION SIGNS
-  DRUMS
-  CONE
-  PRECAST CONCRETE CURB CONSTRUCTION BARRIER (TYPE SPECIFIED)
-  DIRECTION OF TRAFFIC FLOW
-  TRAFFIC DIRECTOR, FLAGGER
-  TRAILER MOUNTED MOUNTED ARROW BOARD SHOWING CAUTION MODE
-  ILLUMINATED FLASHING ARROW MOUNTED ON TOWING VEHICLE SHOWING ARROW PATTERN (Left, Right, Both)
-  TRAFFIC CONTROL TRUCK WITH MOUNTED CRASH CUSHION AND ARROW BOARD SHOWING CAUTION MODE
-  TRAFFIC CONTROL TRUCK WITH MOUNTED CRASH CUSHION AND ARROW BOARD SHOWING ARROW PATTERN (Left, Right, Both)
-  TEMPORARY CRASH CUSHION, INERTIAL BARRIER SYSTEM
-  TEMPORARY CRASH CUSHION, (all other approved)
-  BUFFER ZONE
-  WORK AREA
-  PAINT STRIPING TRUCK OR OTHER OPERATING VEHICLE

GENERAL NOTES:

1. ADVANCE WARNING SIGNS DISTANCES, AND TAPER LENGTHS MAY BE EXTENDED, AT DIRECTION OF THE DEPARTMENT, TO ADJUST FOR REDUCED VISIBILITY DUE TO HORIZONTAL AND VERTICAL CURVATURE OF THE ROADWAY.
2. THE APPROXIMATE LOCATIONS OF THE ILLUMINATED FLASHING ARROW BOARDS ARE SHOWN ON THE TRAFFIC CONTROL PLANS. THESE LOCATIONS MAY BE MODIFIED AS APPROVED BY RE TO ADJUST FOR VISIBILITY DUE TO HORIZONTAL OR VERTICAL CURVATURE OF THE ROADWAY OR TO POSITION AT A SAFER LOCATION. ILLUMINATED FLASHING ARROW BOARDS ARE TO BE USED FOR TEMPORARY LANE CLOSINGS AND AT LOCATIONS SHOWN ON THE TRAFFIC CONTROL PLANS.
3. PRIOR TO ANY ROAD CONSTRUCTION, TRAFFIC CONTROL SIGNS AND DEVICES SHALL BE IN PLACE.
4. RAMPS AND/OR SIDE STREETS ENTERING THE ROADWAY AFTER THE FIRST ADVANCE WARNING SIGN SHALL BE PROVIDED WITH AT LEAST ONE W20-IF SIGN (ROAD WORK AHEAD) AS A MINIMUM.
5. ALL EXISTING ROAD SIGNS, PAVEMENT MARKINGS AND/OR PLOWABLE PAVEMENT REFLECTORS WHICH CONFLICT WITH THE PROPOSED TRAFFIC CONTROL PLAN SHALL BE COVERED, REMOVED OR RELOCATED AS DIRECTED BY THE RE.
6. CONFLICTING OR NON-OPERATING SIGNAL INDICATIONS ON EITHER THE EXISTING, TEMPORARY, OR PROPOSED TRAFFIC SIGNAL SYSTEMS SHALL BE BAGGED OR COVERED.
7. MAINTENANCE AND PROTECTION OF TRAFFIC SHALL BE IN ACCORDANCE WITH THE MANUAL OF UNIFORM TRAFFIC CONTROL DEVICES - PART VI "STANDARDS AND GUIDES FOR TRAFFIC CONTROL FOR STREET AND HIGHWAY CONSTRUCTION, MAINTENANCE, UTILITY, AND INCIDENT MANAGEMENT OPERATIONS", UNLESS OTHERWISE NOTED IN THE PLANS AND SPECIFICATIONS.
8. CONSTRUCTION SIGN W99-2 (GIVE US A BRAKE) SHALL BE LOCATED 200 FEET IN ADVANCE OF PROJECT LIMITS.
9. A W1-6 (ARROW) SIGN MOUNTED ON A BREAKAWAY BARRICADE AND CENTERED ON THE CLOSED WIDTH SHALL BE LOCATED 100 FEET BEYOND EACH INTERSECTION OR MAIN ACCESS POINT WITHIN THE AREA OF A LANE OR SHOULDER CLOSURE.
10. CONSTRUCTION SIGNS R11-4 (ROAD CLOSED TO THRU TRAFFIC) SHALL BE PLACED AT THE INTERSECTING STREETS WHICH ARE CLOSED TO TRAFFIC BECAUSE OF CONSTRUCTION.
11. CONSTRUCTION SIGNS W8-9A (SYMBOL FOR UNEVEN PAVEMENT) AND W8-14A (GROOVED PAVEMENT) SHALL BE USED WHEN SUCH PAVEMENT CONDITIONS EXIST. THE PLACEMENT OF THESE SIGNS SHALL BE AS DIRECTED BY THE RE.
12. MOVING WORK AREAS IN A LANE CLOSURE REQUIRE A TRAILER MOUNTED ILLUMINATED FLASHING ARROW TO REMAIN AT THE END OF THE TAPER, THE TRAFFIC CONTROL TRUCK WITH MOUNTED CRASH CUSHION THAT SHALL MOVE WITH THE WORK AREAS TO KEEP A 70 FEET MIN. AND 150 FEET MAX. BUFFER IN ADVANCE OF EACH WORK AREA.
13. THE CONTRACTOR SHALL SUBMIT A PLAN FOR THE SAFE ACCESS OF CONSTRUCTION VEHICLES THROUGHOUT THE WORK SITE WHERE SPACE CONSTRAINTS PREVENT THE USE OF LANE CLOSURES. THE PLAN SHALL BE SUBMITTED TO THE RE IN ACCORDANCE WITH THE STANDARD SPECIFICATIONS.
14. TRAFFIC SAFETY SERVICES SHALL BE USED IN ACCORDANCE WITH THE STANDARD SPECIFICATIONS FOR TRAFFIC CONTROL.
15. ALL EXCAVATED AREAS WITHIN OR ADJACENT TO THE ROADWAY SHALL BE BACKFILLED AND PLACED ON AT LEAST 6H : 1V SLOPE BEFORE THE END OF EACH WORK DAY. OTHER EXCAVATED AREA WITHIN THE CLEAR ZONE SHALL BE BACKFILLED.
16. WHERE REQUIRED, THE CONTRACTOR SHALL MAKE PROVISIONS FOR MAINTAINING PEDESTRIAN CROSSING LOCATIONS AND TYPE AS DIRECTED BY THE RE.
17. BITUMINOUS CONCRETE PLACED DURING THE VARIOUS CONSTRUCTION STAGES SHALL BE TRANSITIONED ON A MINIMUM 20H : 1V SLOPE TO MEET THE ADJACENT EXISTING GRADE AT THE LONGITUDINAL AND TRANSVERSE LIMITS OF THE STAGE CONSTRUCTION AREAS UNLESS OTHERWISE NOTED ON THE STAGE CONSTRUCTION PLANS.
18. THE PLACEMENT AND OR RELOCATION OF PRECAST CONCRETE CURB, CONSTRUCTION BARRIER SHALL BE DONE DURING APPROVED OFF-PEAK HOURS WHEN TRAFFIC MAY BE REDUCED TO ONE LANE IN EACH DIRECTION.
19. CONSTRUCTION ZONE SPEED LIMIT WILL BE DETERMINED BY THE TRAFFIC SIGNAL & SAFETY ENGINEERING, REGIONAL TRAFFIC ENGINEER - WORK ZONE, AT THE TIME OF OR DURING CONSTRUCTION, AS REQUESTED BY THE R.E..
20. THE SPEED LIMIT, R2-1 (BLACK ON WHITE) WITH ADDED WORK ZONE PLATE (BLACK ON ORANGE) SIGNS SHALL BE LOCATED THROUGH WORK AREAS AS DIRECTED BY THE TRAFFIC SIGNAL & SAFETY ENGINEERING REGIONAL TRAFFIC ENGINEER - WORK ZONE.
21. THE REDUCED SPEED AHEAD SIGN, W3-5(S) (BLACK ON ORANGE) SHALL BE LOCATED IN ADVANCE OF SPEED LIMIT R2-1 SIGNS WHICH REDUCE THE NORMAL POSTED SPEED LIMIT THROUGH THE CONSTRUCTION ZONE.
22. TRAFFIC FINES DOUBLED IN WORK AREA R(NJ)5-17(S) , 4 FEET BY 2.5 FEET SIGN SHALL BE LOCATED 500 FEET AFTER THE FIRST ADVANCE WARNING SIGN, (W20 SERIES) AT EACH WORK AREA LOCATED WITHIN URBAN AREAS. THIS SIGN SHALL ALSO BE USED ON PROJECTS REQUIRING MOVING OPERATIONS IN WHICH CASE THE SIGN SHALL BE MOUNTED ON A SLOW MOVING CONSTRUCTION VEHICLE.
23. THE FINAL HMA SURFACE PAVEMENT SHALL NOT BE CONSTRUCTED UNTIL THE FINAL STAGE OF THE PROJECT UNLESS OTHERWISE DIRECTED BY THE RE OR INDICATED ON THE PLANS. MANHOLES AND INLETS SHALL BE SET TO FINISHED GRADE AND TEMPORARY PAVEMENT RAMPS ARE TO BE CONSTRUCTED AROUND THEM WITH A MINIMUM 20H : 1V SLOPE IN ALL DIRECTIONS USING HOT MIX ASPHALT PAVEMENT. THIS TEMPORARY MATERIAL WILL BE REMOVED IMMEDIATELY PRIOR TO PLACING THE SURFACE COURSE.

24. TRAFFIC CONTROL DEVICES FOR LANE CLOSURES INCLUDING SIGNS, CONES, BARRICADES, ETC. SHALL BE PLACED AS SHOWN ON PLANS. SIGNS SHALL NOT BE PLACED WITHOUT ACTUAL LANE CLOSURES AND SHALL BE IMMEDIATELY REMOVED UPON REMOVAL OF THE CLOSURES.
25. CONES MAY BE SUBSTITUTED FOR DRUMS AND INSTALLED UPON THE APPROVAL OF THE RE.
26. TRAFFIC IMPACT NOTICES AND CHANGES
 - A. TERMS: WHEN THE FOLLOWING TERMS ARE USED, THE INTENT AND MEANING SHALL BE AS FOLLOWS:
 - i. IMPACTS TO NORMAL TRAFFIC FLOW - WORK THAT REQUIRES A PORTION OF THE PAVED ROADWAY BEING BLOCKED OR CLOSED WITH SAFETY DEVICES OR VEHICLES, INCLUDING, BUT NOT LIMITED TO, FULL OR PARTIAL LANE CLOSURES, FULL OR PARTIAL RAMP CLOSURES, SHOULDER CLOSURES, MOVING OPERATIONS, SUCH AS TRAFFIC STRIPING OR SWEEPING, LANE SHIFTS, OR ALTERNATING TRAFFIC. THIS APPLIES EVEN WHEN DETOURS ARE PROVIDED.
 - ii. TEMPORARY LANE CLOSURES - WORK DESCRIBED UNDER "IMPACTS TO NORMAL TRAFFIC FLOW" WHICH IS ROUTINELY SET UP AND REMOVED ON A DAILY BASIS.
 - iii. PERMANENT LANE CLOSURES - WORK DESCRIBED UNDER "IMPACTS TO NORMAL TRAFFIC FLOW" WHICH REMAINS IN PLACE CONTINUOUSLY FOR 24 HOURS OR MORE.
 - B. ADVANCE NOTICES

FOR THE INITIAL START OF WORK THAT REQUIRES "IMPACTS TO NORMAL TRAFFIC FLOW", THE CONTRACTOR SHALL NOTIFY THE RE IN WRITING, ON THE ADVANCE FORM TO-103 PROVIDED BY THE DEPARTMENT, OF THE PROPOSED DATE. THE NOTICE SHALL BE SUBMITTED AT LEAST TWENTY-EIGHT CALENDAR DAYS, BUT NOT MORE THAN SIXTY CALENDAR DAYS, BEFORE THE PROPOSED DATE. START OF WORK THAT IMPACTS NORMAL TRAFFIC FLOW WILL NOT BE PERMITTED PRIOR TO THE DATE STATED IN THE NOTICE. THE CONTRACTOR SHALL CONFIRM, IN WRITING TO THE RE, THE PROPOSED DATE SEVEN (AND/OR FOURTEEN) CALENDAR DAYS BEFORE STARTING THE ESTABLISHMENT OF THE TRAFFIC CONTROL MEASURES FOR THE TRAFFIC IMPACT. THE CONTRACTOR SHALL IMMEDIATELY NOTIFY THE RE IF THE PROPOSED ESTABLISHMENT CAN NOT BE COMPLETED ON THE PROPOSED DATE.

FOR A "PERMANENT LANE CLOSURE", THE CONTRACTOR SHALL NOTIFY THE RE IN WRITING, ON ADVANCE FORM TO-103, OF THE PROPOSED DATE A NEW TRAFFIC PATTERN WILL BE ESTABLISHED. THE NOTICE SHALL BE SUBMITTED AT LEAST TWENTY-EIGHT CALENDAR DAYS, BUT NOT MORE THAN SIXTY CALENDAR DAYS, IN ADVANCE OF THE PROPOSED DATE. START OF A NEW TRAFFIC PATTERN WILL NOT BE PERMITTED PRIOR TO THE DATE STATED IN THE NOTICE. THE CONTRACTOR SHALL CONFIRM, IN WRITING TO THE RE, THE PROPOSED DATE OF THE NEW TRAFFIC PATTERN SEVEN (AND/OR FOURTEEN) DAYS BEFORE STARTING TRAFFIC CONTROL MEASURES FOR THE ESTABLISHMENT OF THE NEW PATTERN. THE CONTRACTOR SHALL IMMEDIATELY NOTIFY THE RE IF THE PROPOSED ESTABLISHMENT CAN NOT BE COMPLETED ON THE PROPOSED DATE.

STARTING THE ESTABLISHMENT OF A NEW PERMANENT TRAFFIC PATTERN SHALL BEGIN NO EARLIER THAN 11:00 PM FRIDAY AND SHALL BE COMPLETED AND READY FOR OPERATIONS BY 6:00 PM THE FOLLOWING SUNDAY. THE ESTABLISHMENT SHALL BE COMPLETED IN ACCORDANCE WITH THE LANE CLOSURE HOURS SPECIFIED IN THE CONTRACT.

ADVANCE NOTICES SENT PRIOR TO THE PRE-CONSTRUCTION MEETING SHALL BE ADDRESSED TO THE CONTACT PERSON AS SPECIFIED IN SUBSECTION 101.04 OF THE SPECIAL PROVISIONS.

C. PROGRESS NOTICES

ALL "IMPACTS TO NORMAL TRAFFIC FLOW" SCHEDULED FOR THE SEVEN DAY PERIOD STARTING ON THE FOLLOWING MONDAY SHALL BE SUBMITTED TO THE RE BY 9:00 AM OF EACH FRIDAY ON WEEKLY FORM TO-101 PROVIDED BY THE DEPARTMENT.

EACH DAY OF "TEMPORARY LANE CLOSURES" SHALL BE SUBMITTED TO THE RE BY 9:00 AM THE DAY IN ADVANCE OF THE START OF THOSE OPERATIONS ON DAILY FORM TO-102 PROVIDED BY THE DEPARTMENT.

"TEMPORARY LANE CLOSURES" FOR WEEKENDS SHALL BE SUBMITTED TO THE RE BY 9:00 AM ON THE IMMEDIATELY PRECEDING FRIDAY ON THE DAILY FORM TO-102 PROVIDED BY THE DEPARTMENT.

D. CHANGES TO THE SCHEDULED CLOSURES

REQUEST FOR A CHANGE TO THE TRAFFIC CONTROL REQUIREMENTS IN THE CONTRACT DOCUMENTS SHALL BE SUBMITTED IN WRITING TO THE RE AS FOLLOWS:

CHANGES TO THE SCHEDULED HOURS FOR "TEMPORARY LANE CLOSURES" SHALL BE SUBMITTED TO THE R.E. AT LEAST EIGHT CALENDAR DAYS IN ADVANCE OF WHEN THE CHANGE IS PROPOSED TO START.

OTHER PROPOSED CHANGES TO "TEMPORARY LANE CLOSURES" AND ALL CHANGES TO "PERMANENT LANE CLOSURES" SHALL BE SUBMITTED TO THE RE AS SPECIFIED IN THE SPECIFICATIONS.

TCD-1

NEW JERSEY DEPARTMENT OF TRANSPORTATION

TRAFFIC CONTROL DETAILS

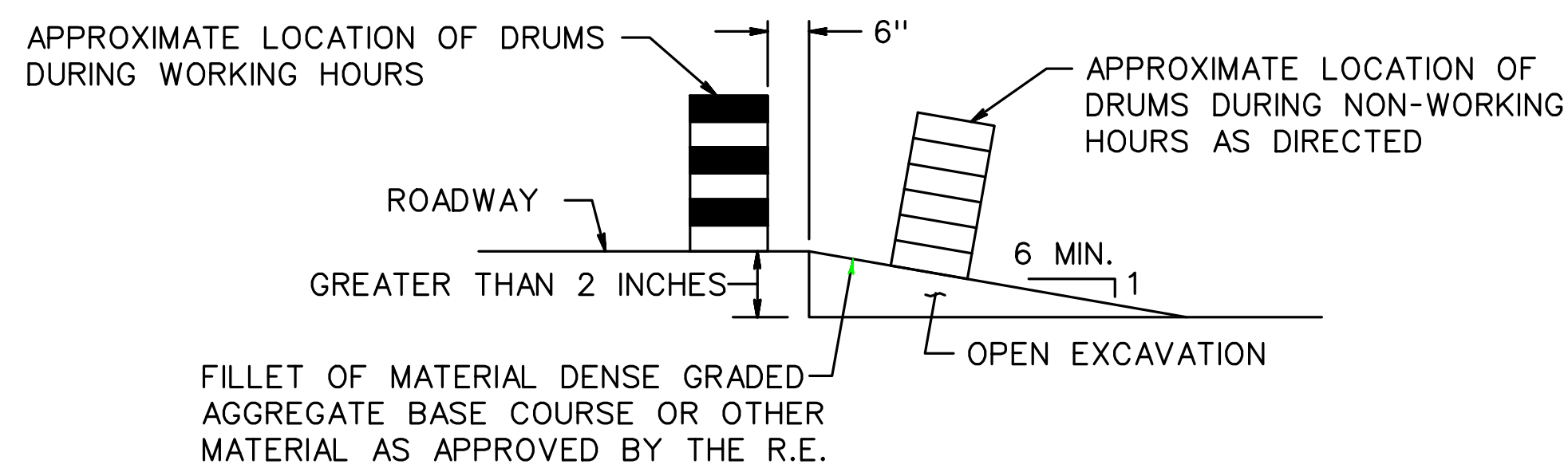

NOTE:
ESCAPE RAMPS MUST BE CONSTRUCTED AND MAINTAINED DURING NON-WORKING HOURS WHERE A VERTICAL DROP GREATER THAN 2 INCHES EXISTS ADJACENT TO TRAVELED LANE.

ESCAPE RAMP DETAIL

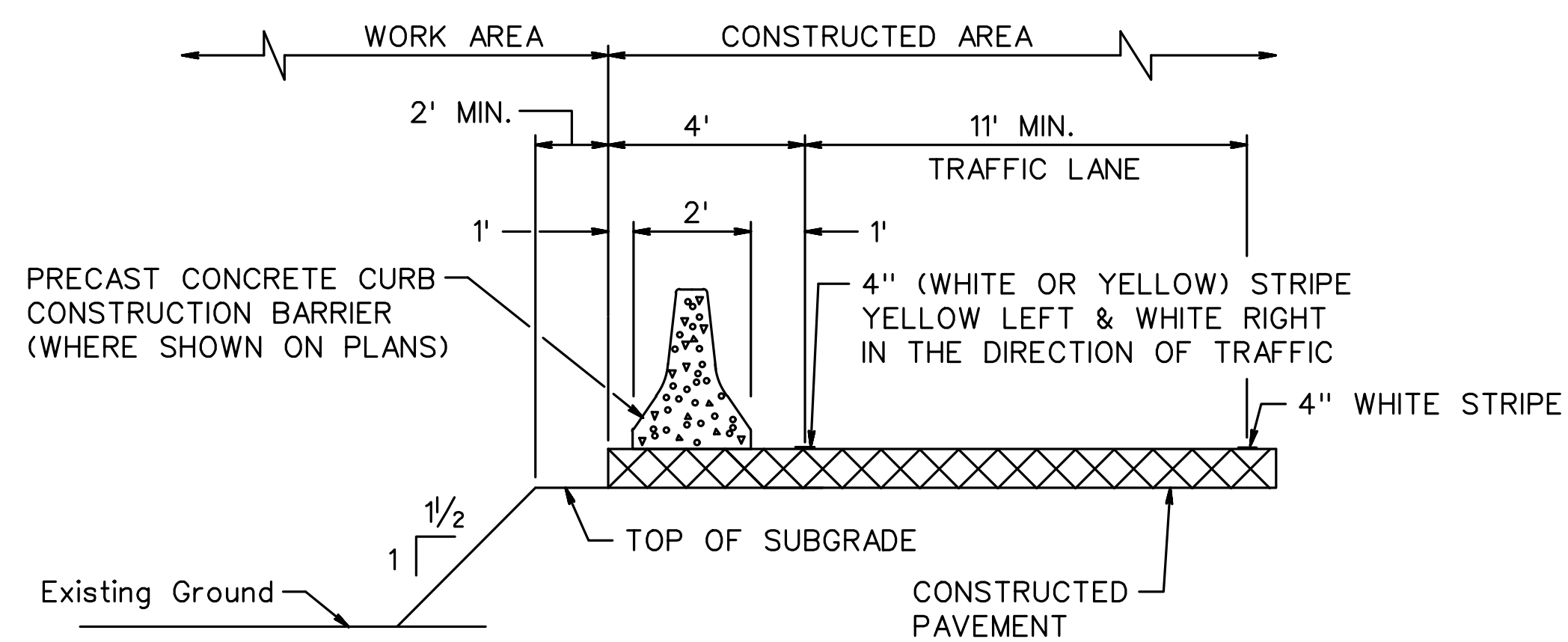

TYPICAL SECTION

PLACEMENT OF PRECAST CONCRETE CONSTRUCTION BARRIER

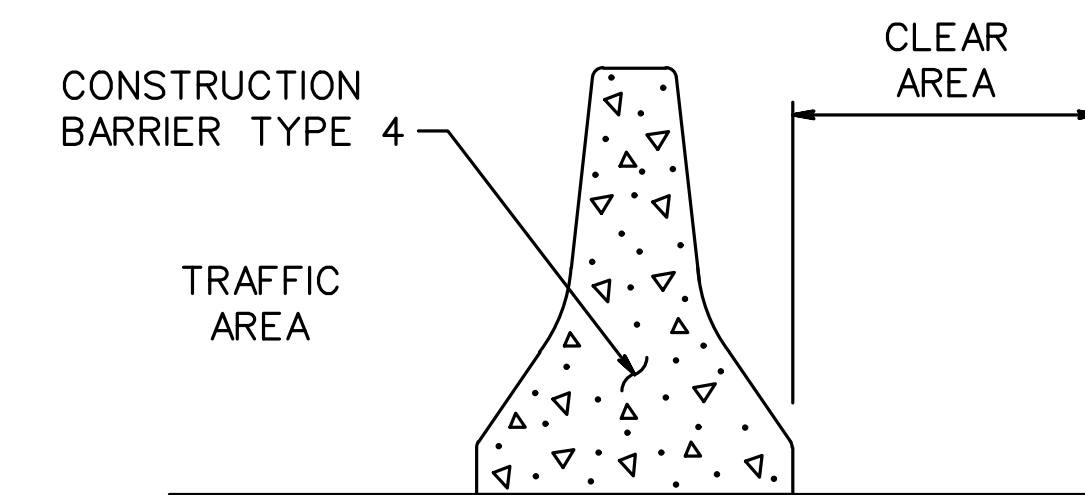

NOTES:

1. CHANGES TO THE PROPOSED JOINT CLASS AT ANY LOCATION MUST BE APPROVED BY THE DEPT.
2. NO ROADWAY DROP OFFS, OBSTRUCTIONS, STORAGE OF MATERIALS OR WORK WILL BE PERMITTED IN THE CLEAR AREA UNLESS APPROVED BY THE R.E.

STAGE	LOCATION	JOINT CLASS
	RTE. STA. TO	

JOINT CLASS	CLEAR AREA
A	20 INCHES
B	16 INCHES
C	11 INCHES

CONSTRUCTION BARRIER, TYPE 4
JOINT CLASS AND CLEAR AREA

REGULATORY APPROACH SPEED OF TRAFFIC MILES/HOUR	RECOMMENDED SIGHT DISTANCE TO BEGINNING OF CHANNELIZING TAPERS		
	DESIRABLE		MINIMUM
	RURAL FEET	URBAN FEET	RURAL AND URBAN FEET
25	375	525	150
30	450	625	200
35	525	725	250
40	600	825	325
45	675	925	400
50	750	1025	475
55	875	1150	550
60	1000	1275	650
65	1050		725

NOTES:

1. AVOIDANCE MANEUVER IS FOR A SPEED, PATH, AND/OR DIRECTION CHANGE PRIOR TO THE BEGINNING OF CHANNELIZING TAPERS.
2. RECOMMENDED DISTANCES BETWEEN TWO SEPARATE LANE CLOSURES SHALL BE DOUBLE THE VALUES SHOWN ABOVE.
3. RURAL AND URBAN ROAD DESIGNATIONS SHALL BE AS DEFINED IN THE NJDOT STATE HIGHWAY STRAIGHT LINE DIAGRAMS.
4. DESIRABLE VALUES SHALL BE PROVIDED WHEREVER POSSIBLE. IF IT IS NOT FEASIBLE OR PRACTICAL TO PROVIDE DESIRABLE VALUES BECAUSE OF HORIZONTAL OR VERTICAL CURVATURE OR IF RELOCATION OF THE TAPER IS NOT POSSIBLE, THEN MINIMUM VALUES CAN BE APPLIED. WHEN MINIMUM VALUES ARE USED, SPECIAL ATTENTION SHOULD BE GIVEN TO THE USE OF SUITABLE TRAFFIC CONTROL DEVICES FOR PROVIDING ADVANCED WARNING OF THE CONDITIONS THAT ARE LIKELY TO BE ENCOUNTERED.
5. TAPERS SHALL BE LOCATED TO MAXIMIZE THE VISIBILITY OF THEIR TOTAL LENGTH.

REGULATORY APPROACH SPEED OF TRAFFIC MILES/HOUR	RECOMMENDED TAPER LENGTH AND SPACING FOR CHANNELIZING TAPERS					RECOMMENDED SPACING ALONG TANGENTS	
	MINIMUM TAPER RATIO IN LENGTH PER FOOT OF WIDTH	MINIMUM TAPER LENGTH L - FOR LANE WIDTHS			MAXIMUM DEVICE (B) SPACING ALONG TAPERS IN FEET	MAXIMUM DEVICE (D) SPACING ALONG TANGENTS IN FEET	
		10'	11'	12'			
25	10.5:1	105	115	125	25	50	
30	15:1	150	165	180	30	60	
35	20.5:1	205	225	245	35	70	
40	27:1	270	300	325	40	80	
45	45:1	450	495	540	45	90	
50	50:1	500	550	600	50	100	
55	55:1	550	605	660	55	110	
60	60:1	600	660	720	60	120	
65	65:1	650	715	780	65	130	

NOTE:

THE MAXIMUM DEVICE SPACING ALONG CURVES SHALL BE AS DEFINED FOR TAPERS (B) IN THE ABOVE TABLE.

N.T.S.

TCD-2

NEW JERSEY DEPARTMENT OF TRANSPORTATION

TRAFFIC CONTROL DETAILS

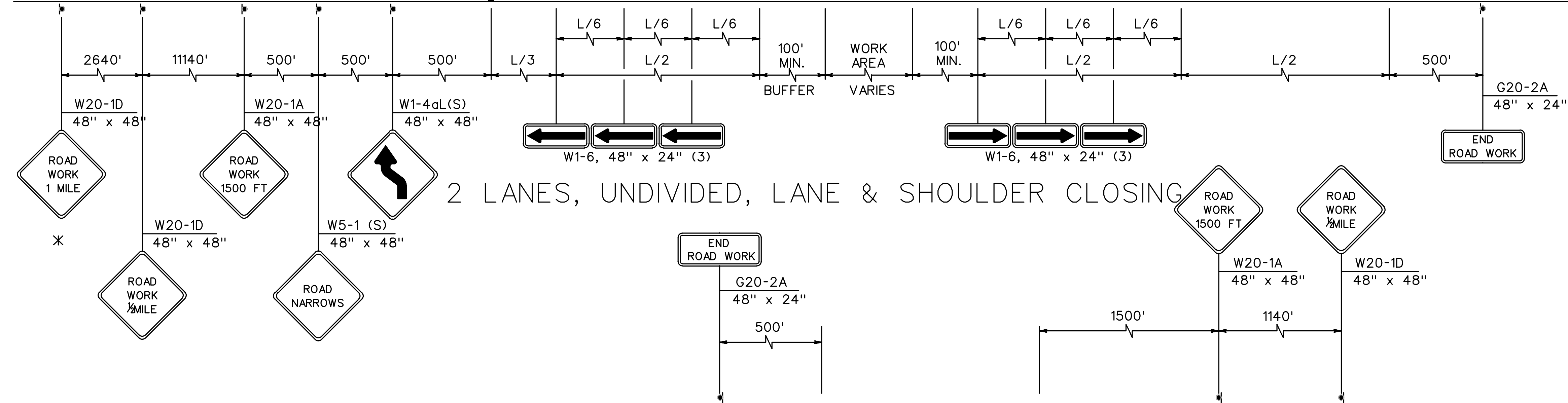
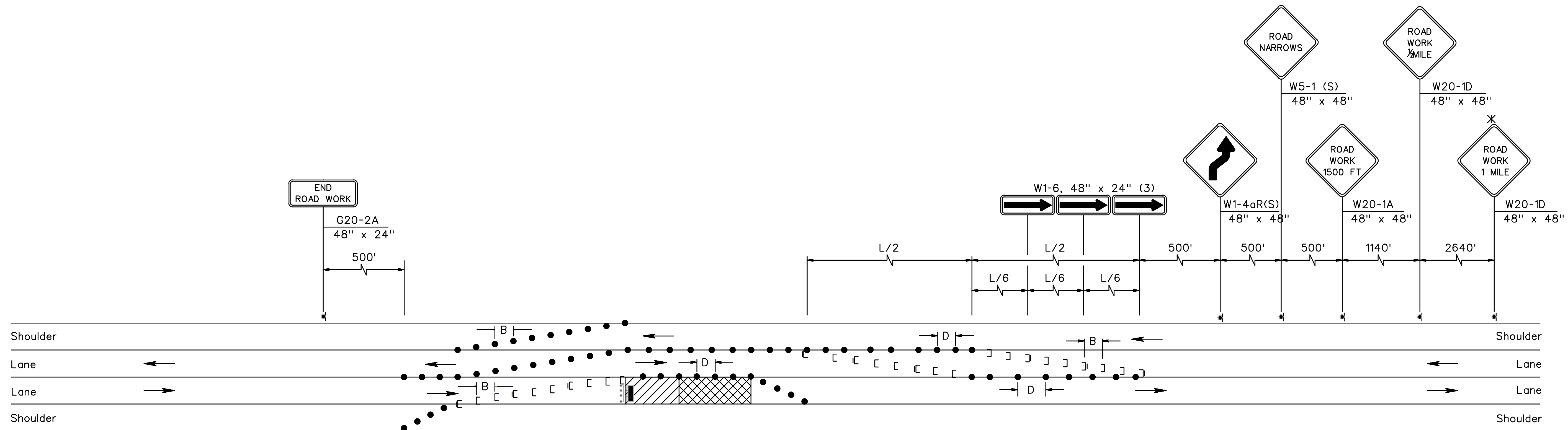

2 LANES, UNDIVIDED, LANE & SHOULDER CLOSING

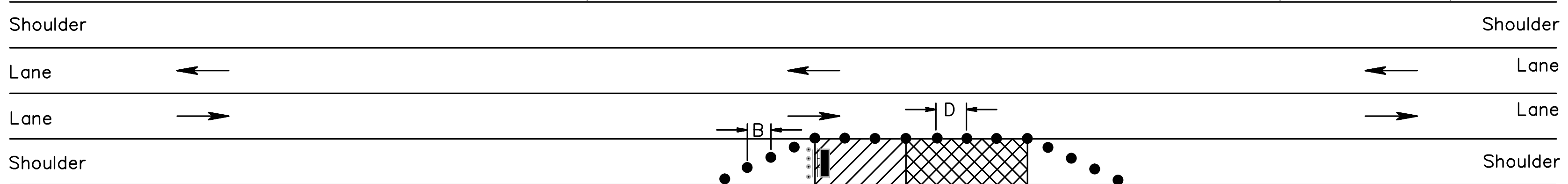

2 LANES, UNDIVIDED, SHOULDER CLOSING

* THIS SIGN SHALL BE INSTALLED FOR ROADS WITH A SPEED LIMIT OF 45 M.P.H. OR GREATER UNLESS OTHERWISE DIRECTED BY THE RE.

NOTE:
SEE RECOMMENDED TAPER LENGTH AND SPACING TABLE ON SHEET TCD-2 FOR VALUES OF L, B AND D.

N.T.S.



R8-8 SIGN DETAIL
NOT TO SCALE

TCD-3
NEW JERSEY DEPARTMENT OF TRANSPORTATION
TRAFFIC CONTROL DETAILS

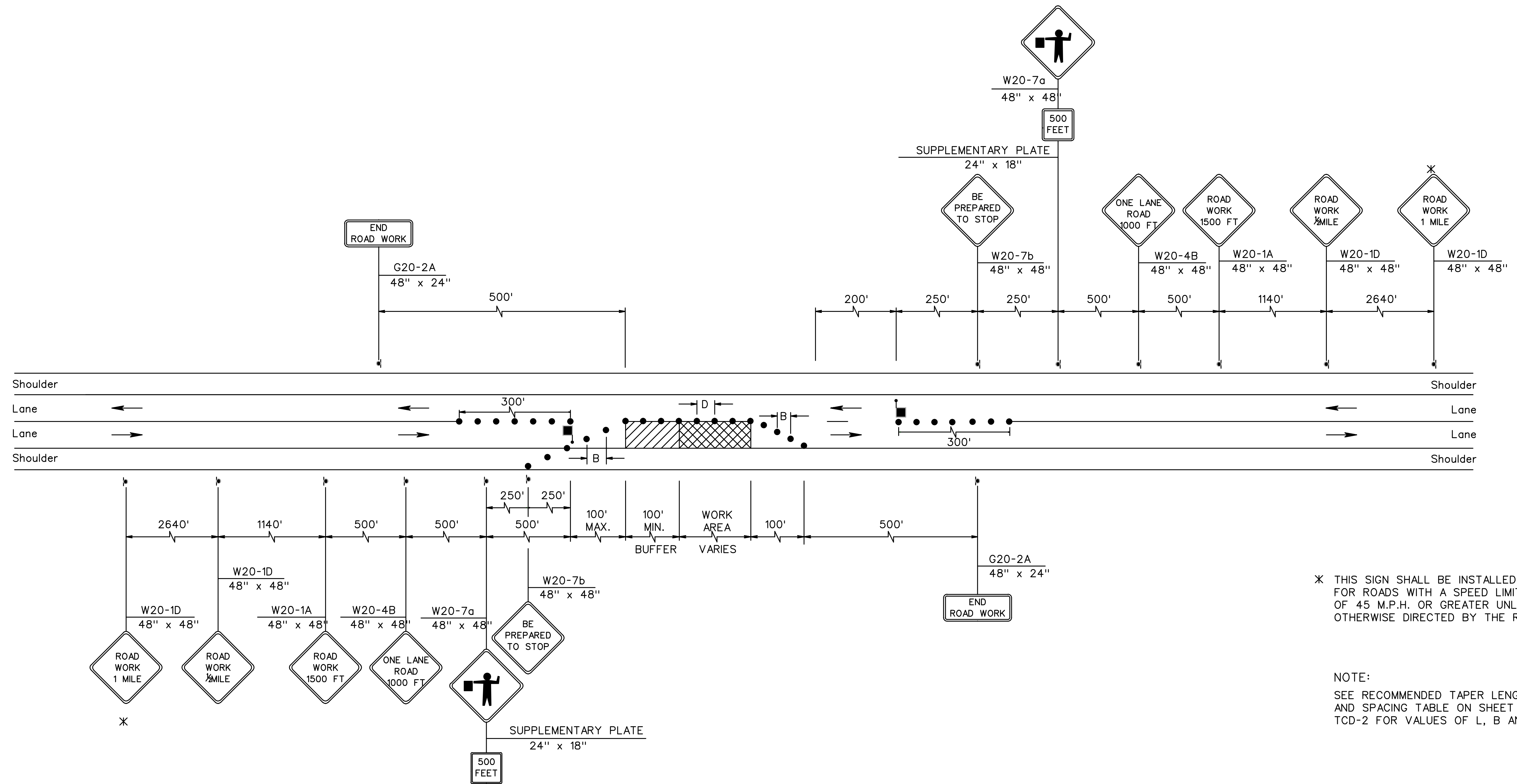

* THIS SIGN SHALL BE INSTALLED FOR ROADS WITH A SPEED LIMIT OF 45 M.P.H. OR GREATER UNLESS OTHERWISE DIRECTED BY THE RE.

NOTE:
SEE RECOMMENDED TAPER LENGTH AND SPACING TABLE ON SHEET TCD-2 FOR VALUES OF L, B AND D.

2 LANES, UNDIVIDED, LANE & SHOULDER CLOSING W/FLAGGING

N.T.S.

TCD-4

NEW JERSEY DEPARTMENT OF TRANSPORTATION

TRAFFIC CONTROL DETAILS

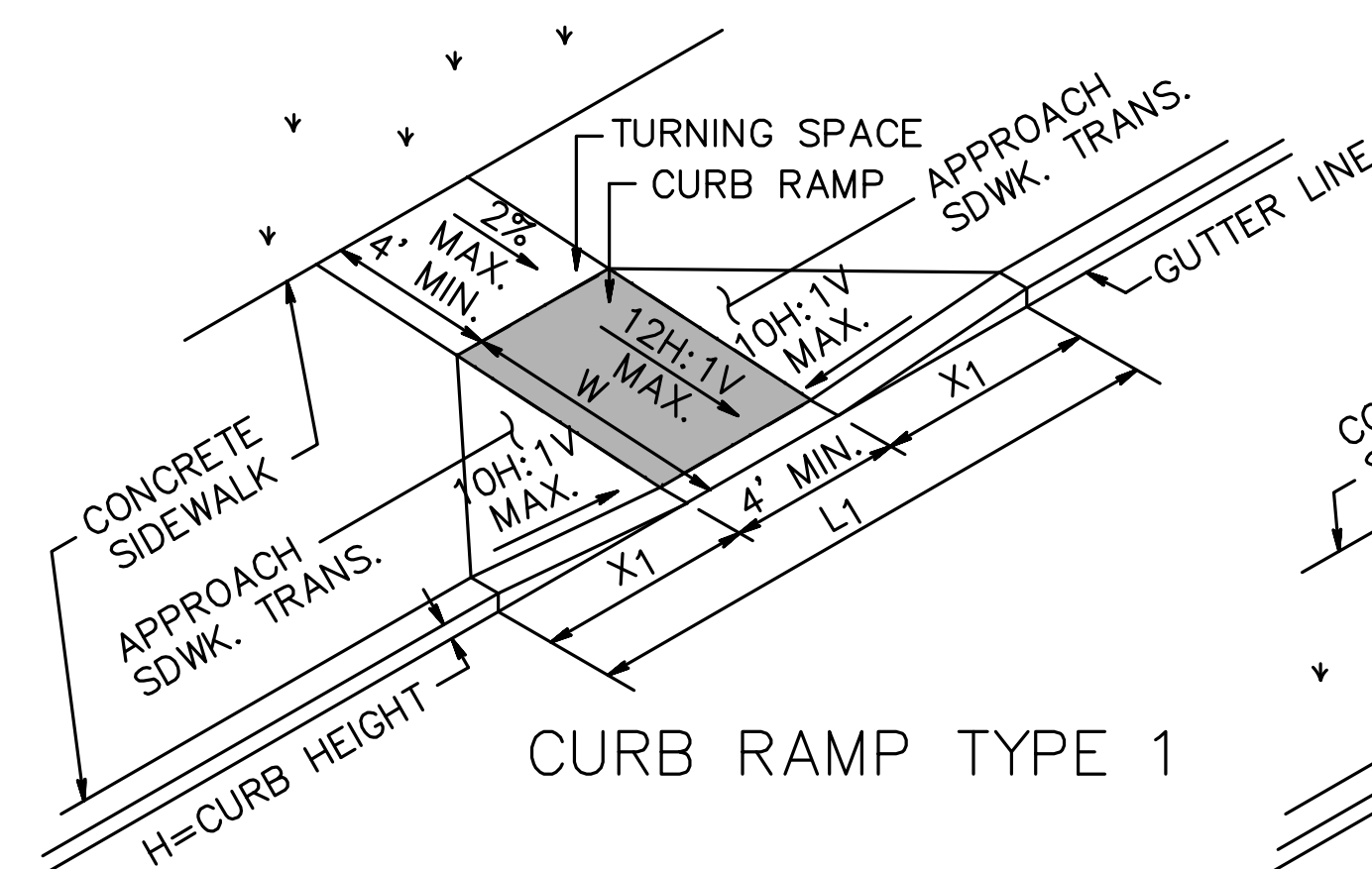

CURB RAMP TYPE 1

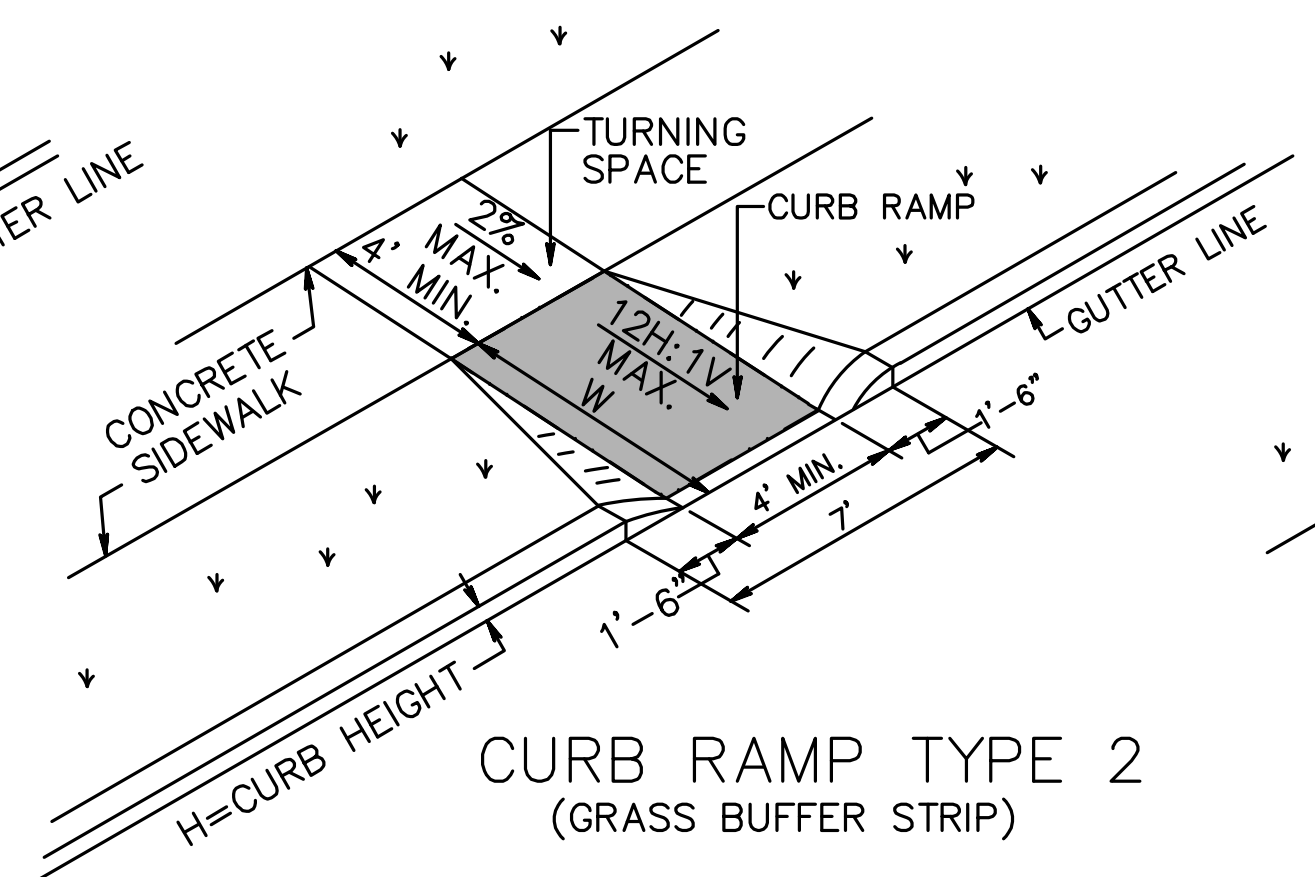

CURB RAMP TYPE 2
(GRASS BUFFER STRIP)

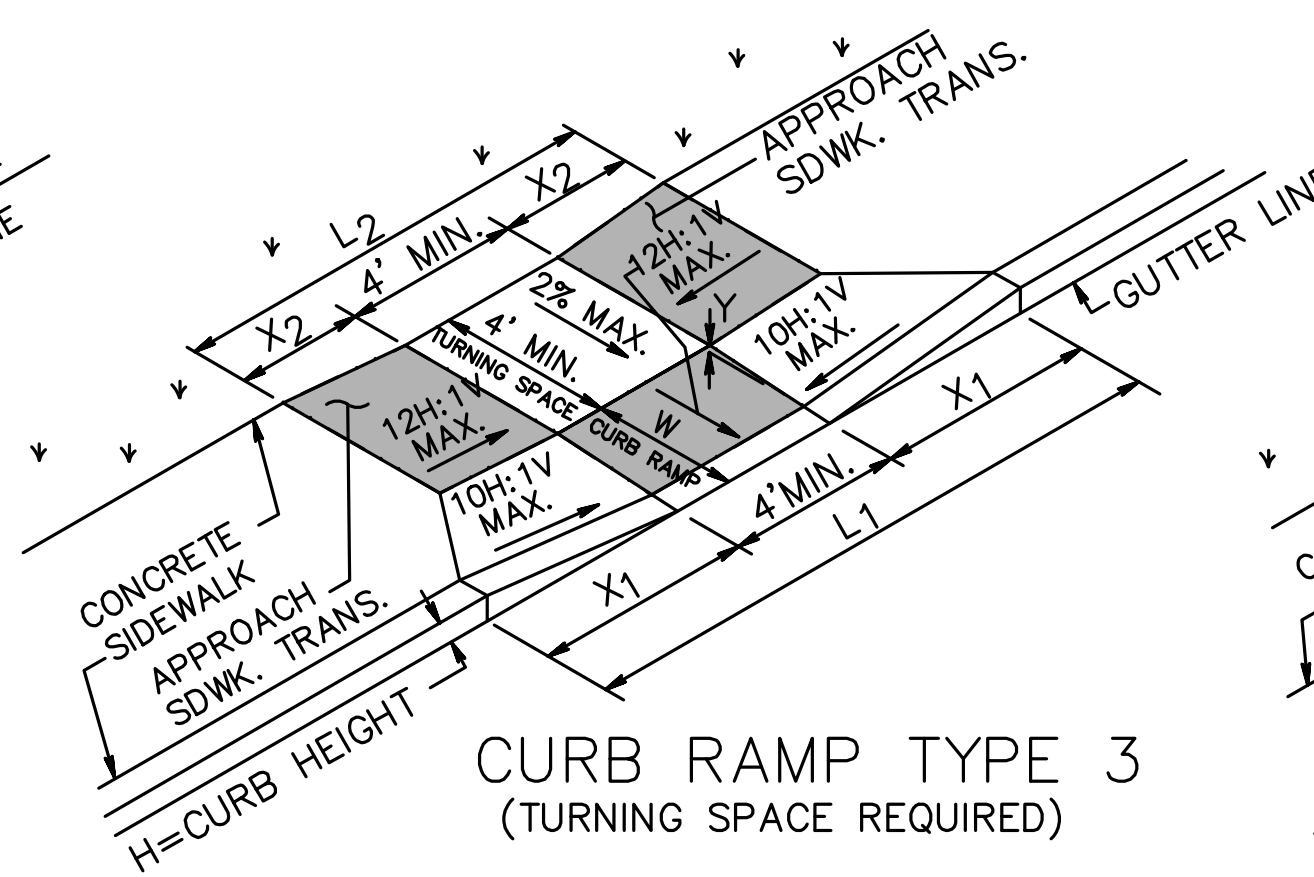

CURB RAMP TYPE 3
(TURNING SPACE REQUIRED)

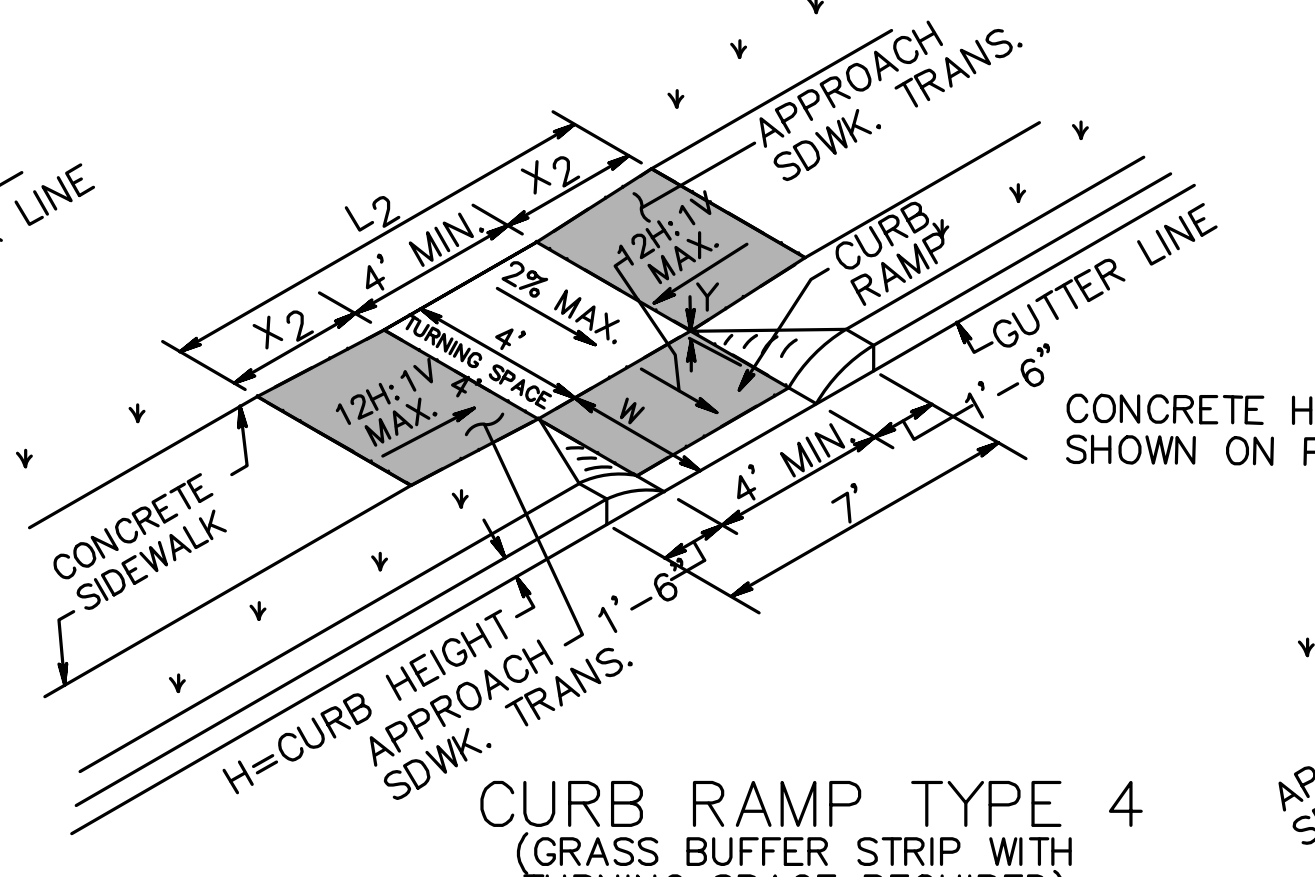

CURB RAMP TYPE 4
(GRASS BUFFER STRIP WITH
TURNING SPACE REQUIRED)

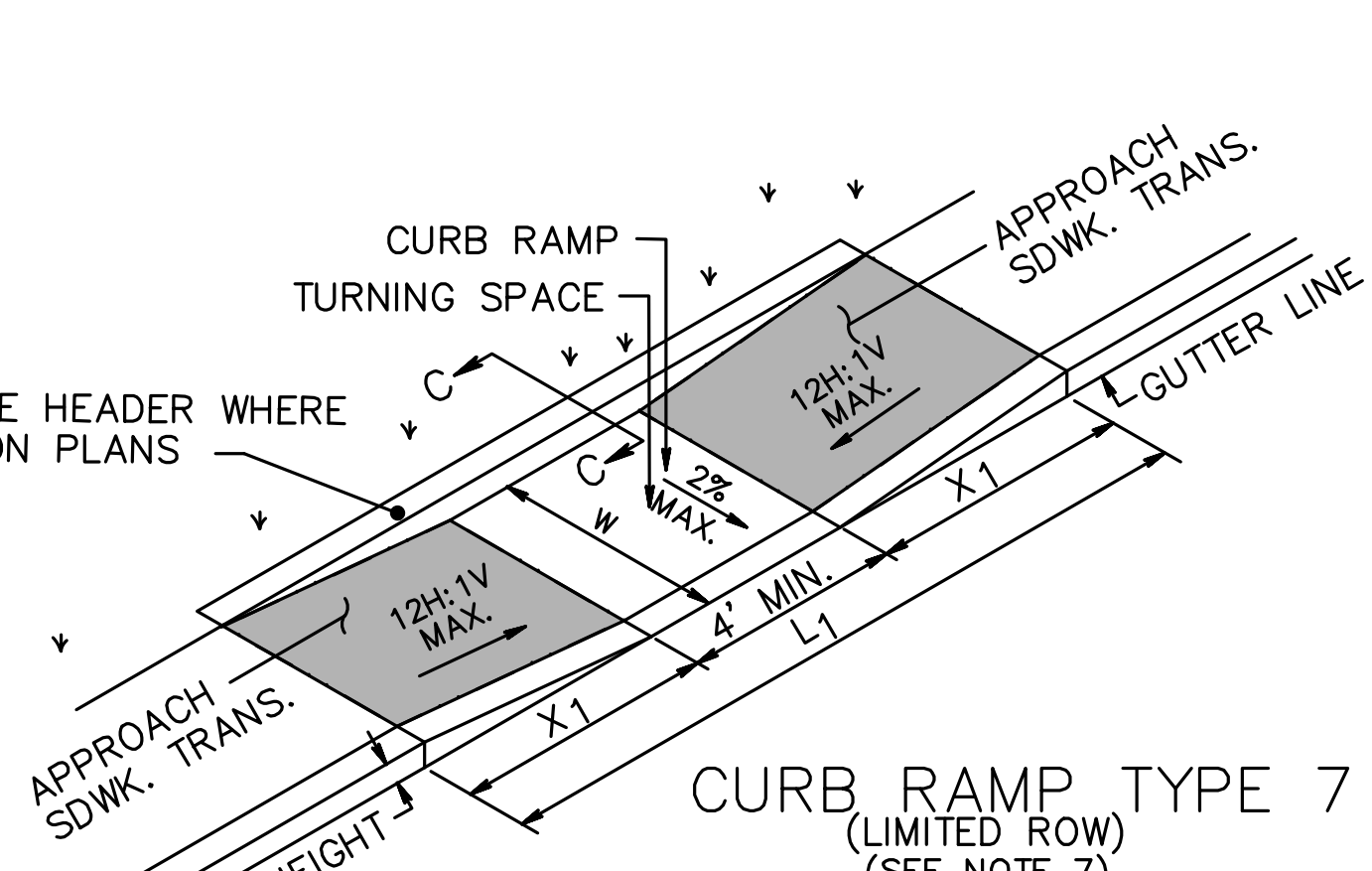

CURB RAMP TYPE 7
(LIMITED ROW)
(SEE NOTE 7)

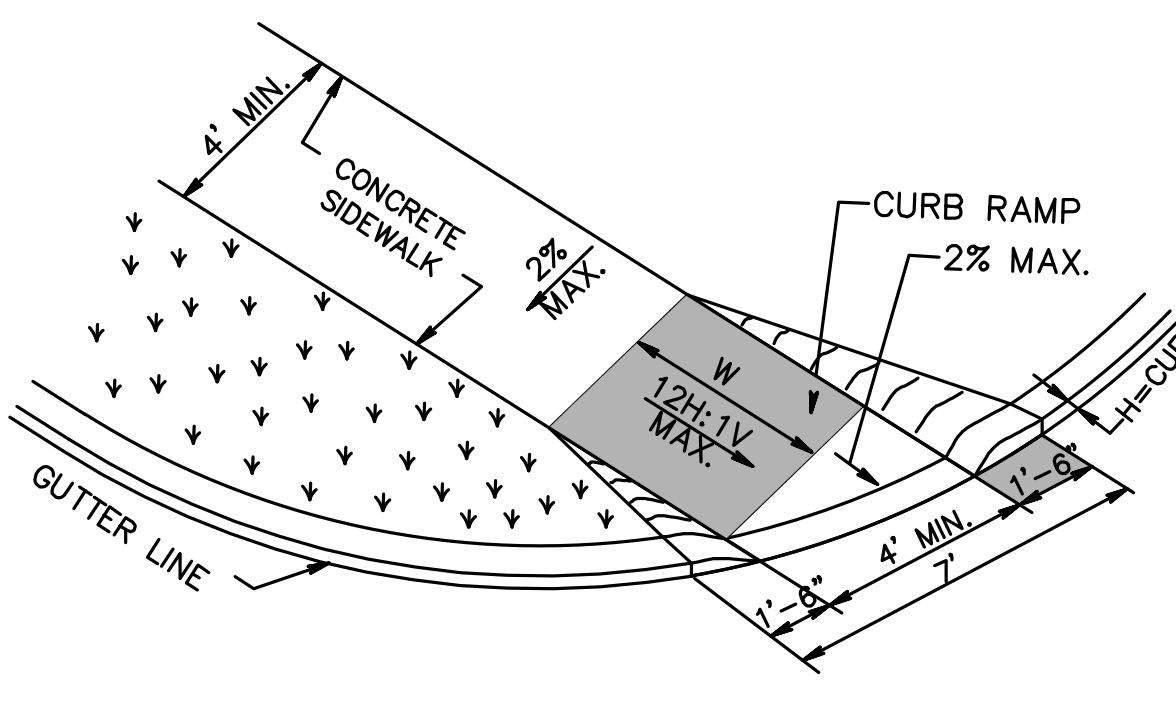

CURB RAMP TYPE 5

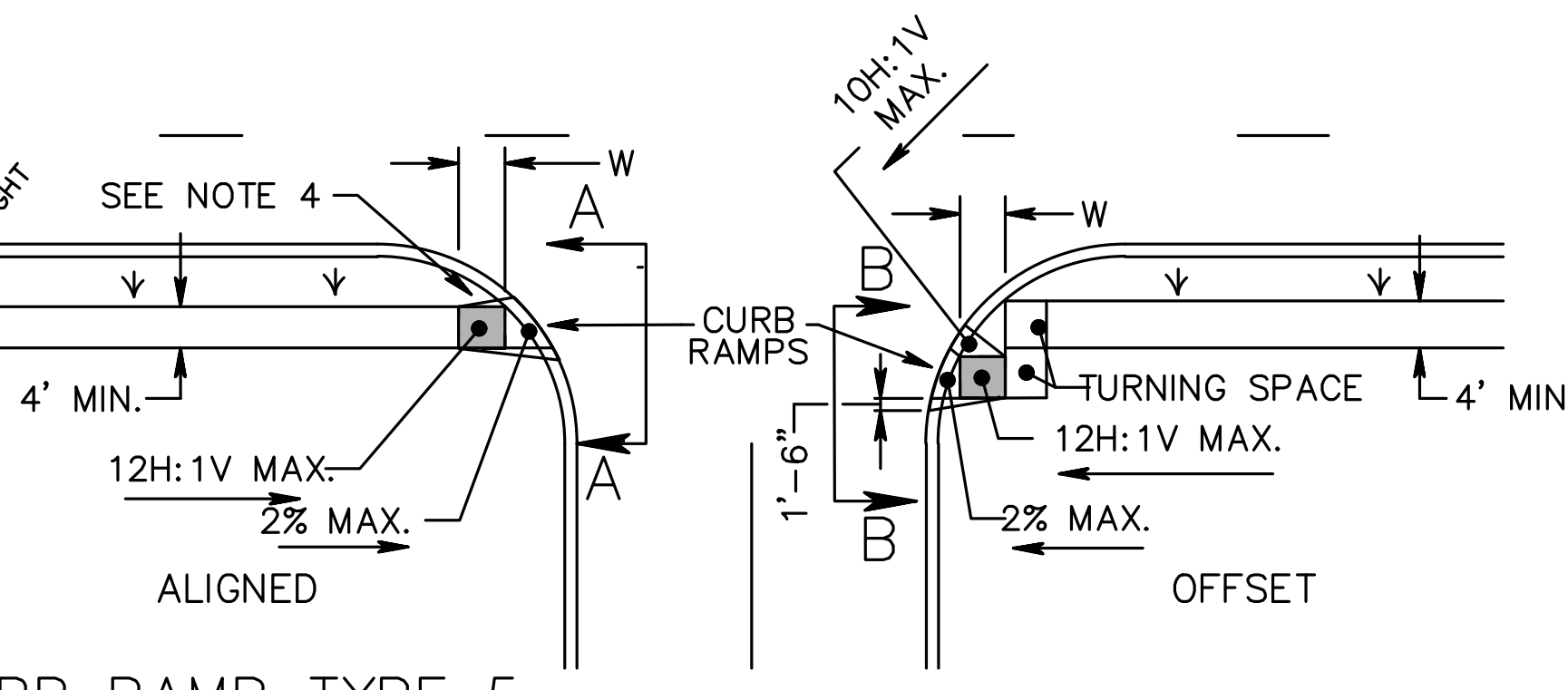

CURB RAMP TYPE 6

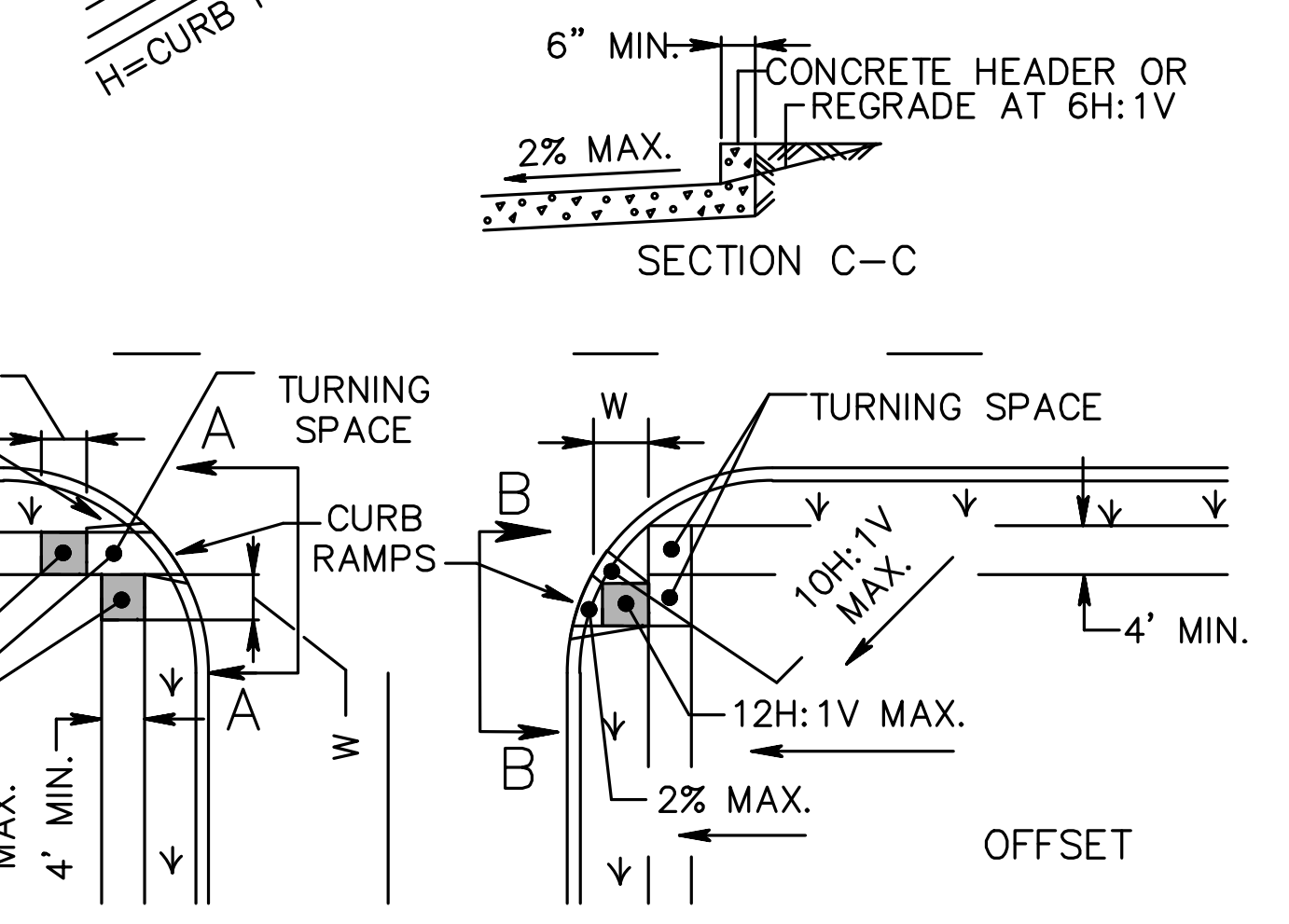

SECTION C-C

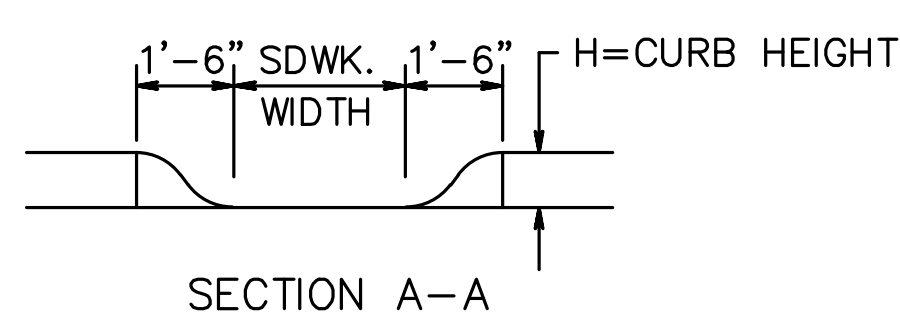

SECTION A-A

NOTE:
CURB RAMP OPENING TO BE FLUSH WITH ROADWAY PAVEMENT (CURB RAMP TYPES 5 & 6).

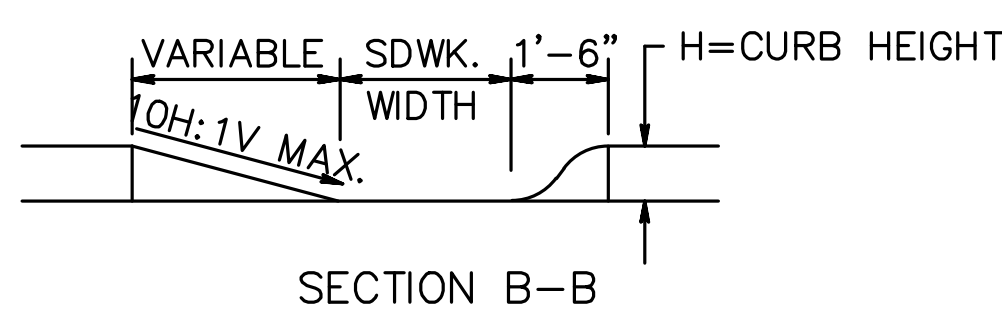

SECTION B-B

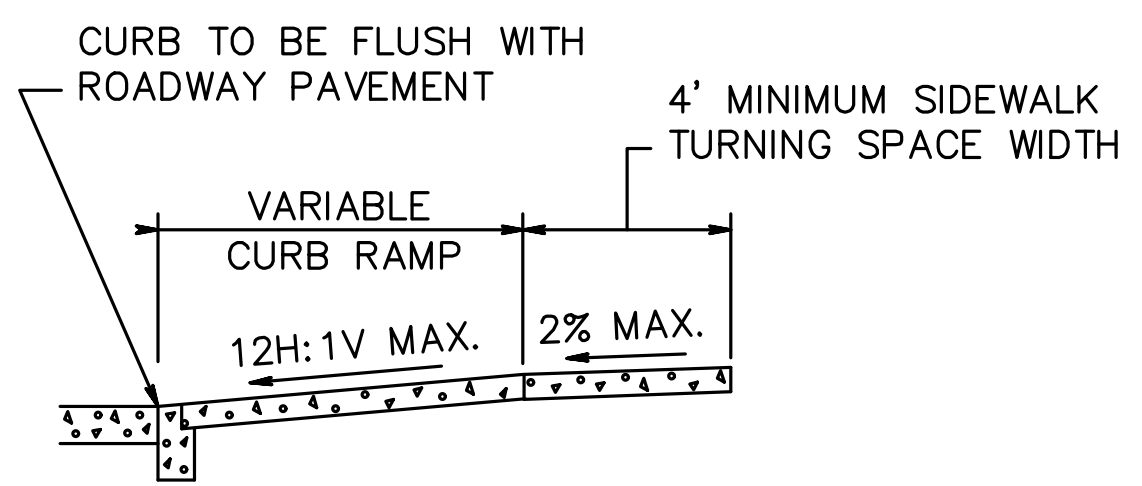

SECTION THROUGH CURB RAMPS 1 THROUGH 4

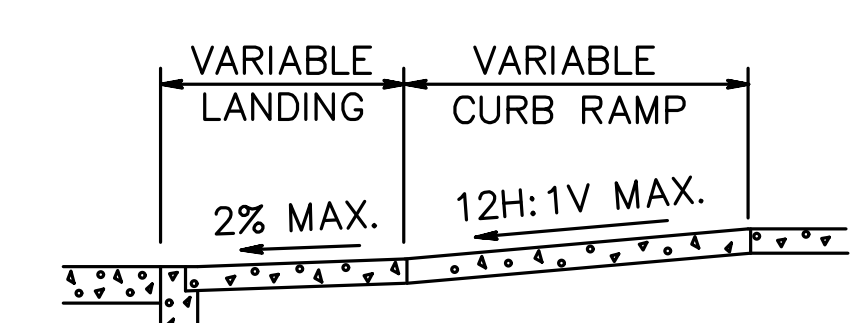

SECTION THROUGH CURB RAMPS 5 AND 6

- NOTES:
- KEEP TURNING SPACE, APPROACH SIDEWALK TRANSITIONS, AND CURB RAMP CLEAR OF OBSTRUCTIONS THAT PROTRUDE ABOVE THE SIDEWALK.
 - FOR DIMENSIONS SEE CD-606-1B AND CD-606-1C.
 - CURB (DROPPED CURB) GUTTERLINE TO BE FLUSH WITH ROADWAY PAVEMENT A MINIMUM OF 4 FEET AT ALL CURB RAMPS.
 - FOR CURB RAMP TYPES 5 AND 6, IF A GRASS BUFFER DOES NOT EXIST, SLOPE CURB TO EQUAL SLOPE OF ADJACENT CURB RAMP.
 - SIDEWALK AND CURB RAMP WITHIN AREA ENCLOSED BY HEAVY LINES INDICATES THE PAY LIMIT FOR CONCRETE SIDEWALK OF THE APPROPRIATE ADJACENT THICKNESS.
 - CURB AND HEADER WITHIN AREA ENCLOSED BY HEAVY LINES INDICATES THE PAY LIMIT FOR VERTICAL CURB OR SLOPING CURB OF THE APPROPRIATE ADJACENT SIZE AND KIND.
 - WHERE THE DISTANCE FROM THE GUTTER LINE TO THE OUTSIDE EDGE OF SIDEWALK IS 6 FEET OR LESS, USE CURB RAMP TYPE 7, INSTEAD OF CURB RAMP TYPE 1 THROUGH 4.
 - CROSSWALKS AND STOP LINES MAY BE MARKED OR UNMARKED. SEE PLANS.
 - DIMENSIONS SHOWN IN TABLES ARE FOR 3 INCH TO 9 INCH CURB HEIGHTS. WHERE THE CURB HEIGHTS ARE OTHER THAN WHAT IS PROVIDED IN THE TABLES, THE DIMENSIONS OF THE RAMPS WILL HAVE TO BE CALCULATED BASED ON CROSS SLOPES SHOWN.
 - THE 12H:1V MAX SLOPE IS THE RUNNING SLOPE FOR CURB RAMPS, BUT ONLY THE 12H:1V SLOPE MEASURED AS X₂ IS THE RUNNING SLOPE FOR TYPE 3 AND TYPE 4 CURB RAMPS. ENSURE THE RUNNING SLOPE OF CURB RAMPS DOES NOT REQUIRE ITS LENGTH TO EXCEED 15 FEET. THE RUNNING SLOPE MAY EXCEED THE 12H:1V MAX SLOPE SO AS NOT TO EXCEED THE 15 FEET MAXIMUM LENGTH.

CURB RAMP NOTES:

- THE MAXIMUM CROSS SLOPE OF SIDEWALKS SHALL BE 2%.
- THE MAXIMUM LONGITUDINAL TRANSITION SLOPE OF SIDEWALKS SHALL BE 5%.
- THE MAXIMUM LONGITUDINAL SLOPE OF CURB RAMPS SHALL BE 8%.
- THE CONTRACTOR SHALL MAINTAIN POSITIVE DRAINAGE ALONG ALL SIDEWALKS, CURB RAMPS AS WELL AS ADJACENT TO ALL SIDEWALKS. STORMWATER RUNOFF SHALL NOT BE BLOCKED BY SIDEWALKS OR CURBS.
- FOR TYPE 5 & TYPE 6 RAMPS, LEADING EDGE OF DETECTABLE WARNING SURFACE MUST BE LOCATED A MAXIMUM OF 5 FEET FROM EDGE OF TRAVELWAY. THIS REQUIREMENT MAY WARRANT MULTIPLE DETECTABLE WARNING SURFACES FOR A SINGLE RAMP.
- THERE MUST BE A MINIMUM OF 24 INCH OF DETECTABLE WARNING SURFACE IN THE DIRECTION OF PEDESTRIAN TRAVEL, THE FULL WIDTH OF THE SIDEWALK. THIS REQUIREMENT MAY WARRANT MULTIPLE DETECTABLE WARNING SURFACES FOR A SINGLE RAMP.
- A MINIMUM 4' X 4' LANDING AREA, GRADED AT A MAXIMUM SLOPE OF 2% IN ALL DIRECTIONS, MUST BE PROVIDED AT THE TOP OF EVERY RAMP.

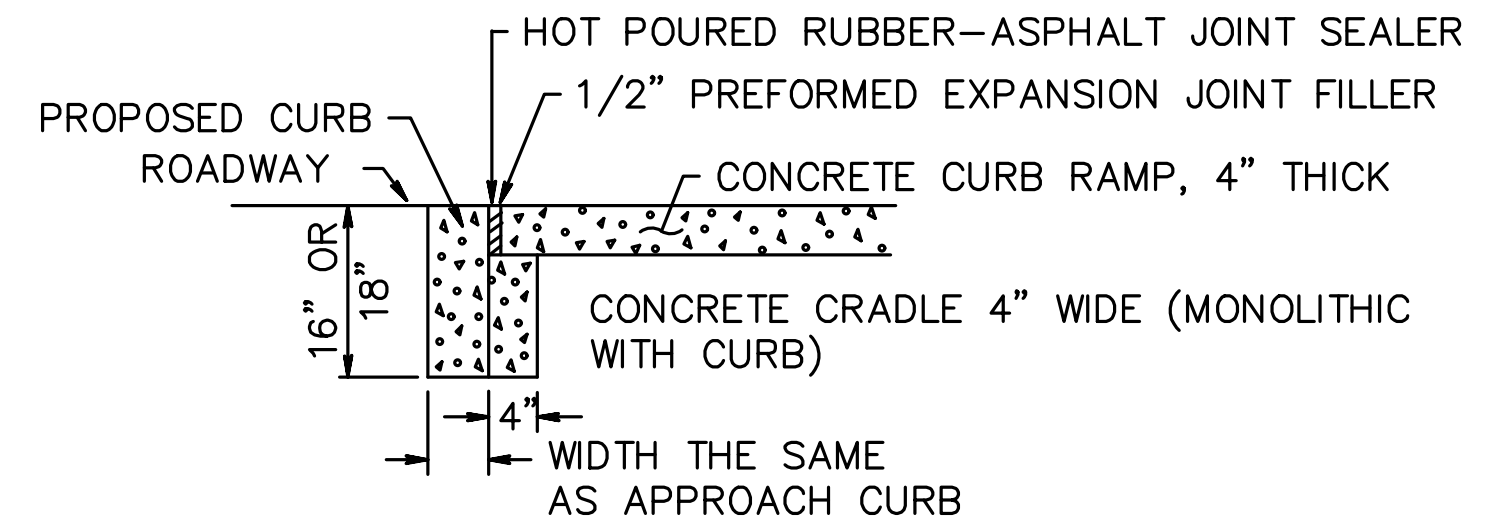

DROPPED CURB AND CRADLE

CONCRETE SIDEWALK
(PUBLIC SIDEWALK CURB RAMP)
N.T.S.

CD-606-1

NEW JERSEY DEPARTMENT OF TRANSPORTATION

CONSTRUCTION DETAILS

CURB RAMPS

CD-606-1.1

BDC612D-05-MODIFICATION TO CURB RAMP DETAIL
BDC607D-01-ORIGINAL SHEET

pen table- \\N\DOT\PRJ\WS\8system\NJDOT\WS\Projects\NJDOT\Eng\pict\TBLs\Roadway\Details\TX17.tbl
 scale- 63.073306:1,000000
 date- 28-SEP-2016 11:07
 ID-TP2VILL

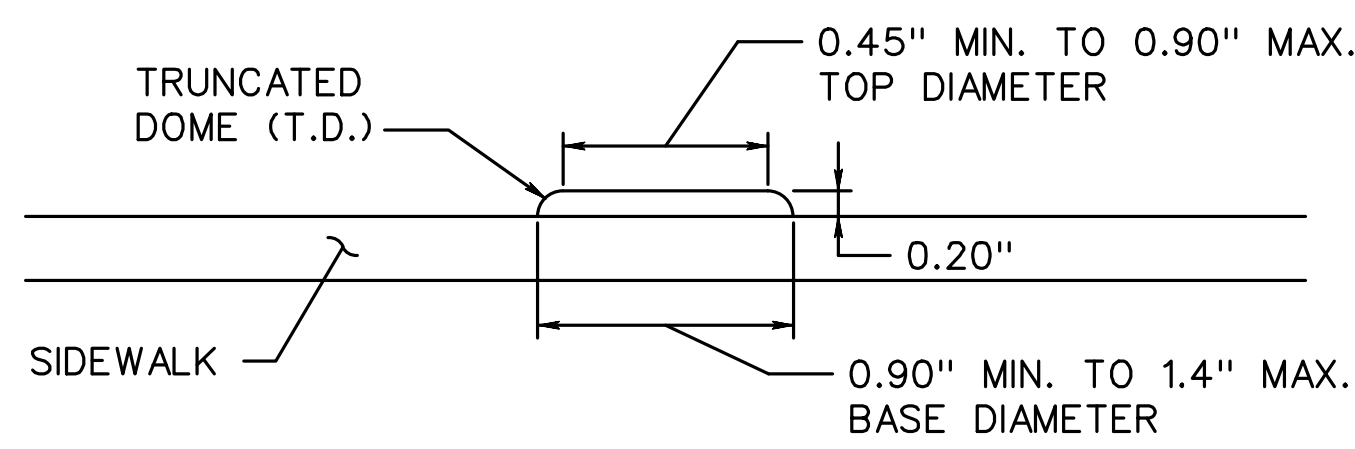
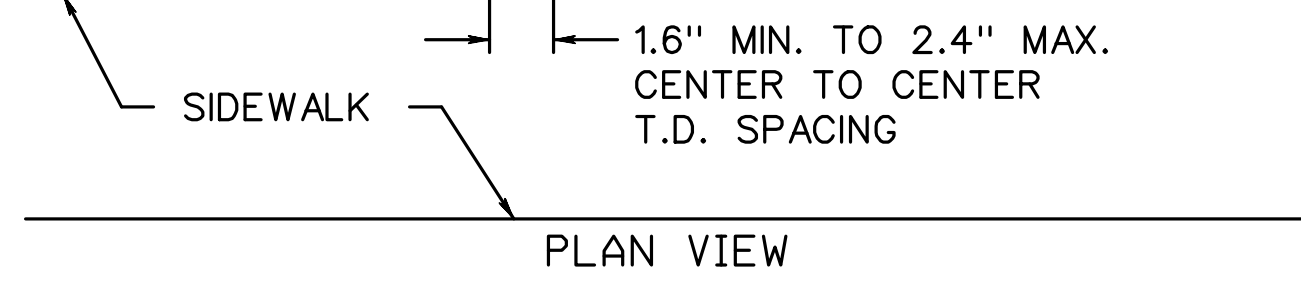
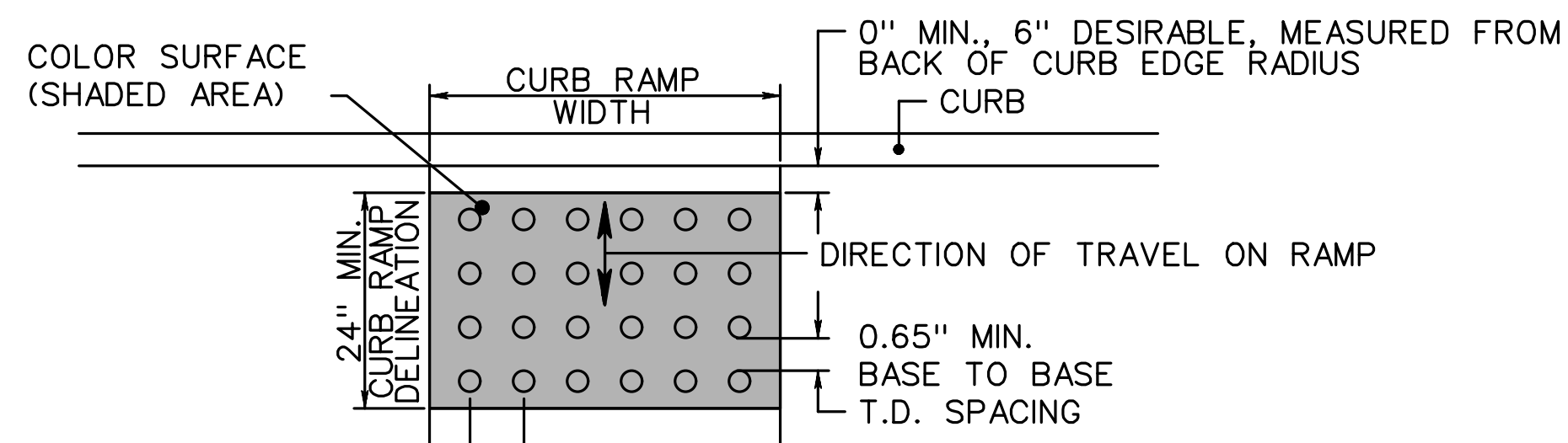

DETECTABLE WARNING SURFACE

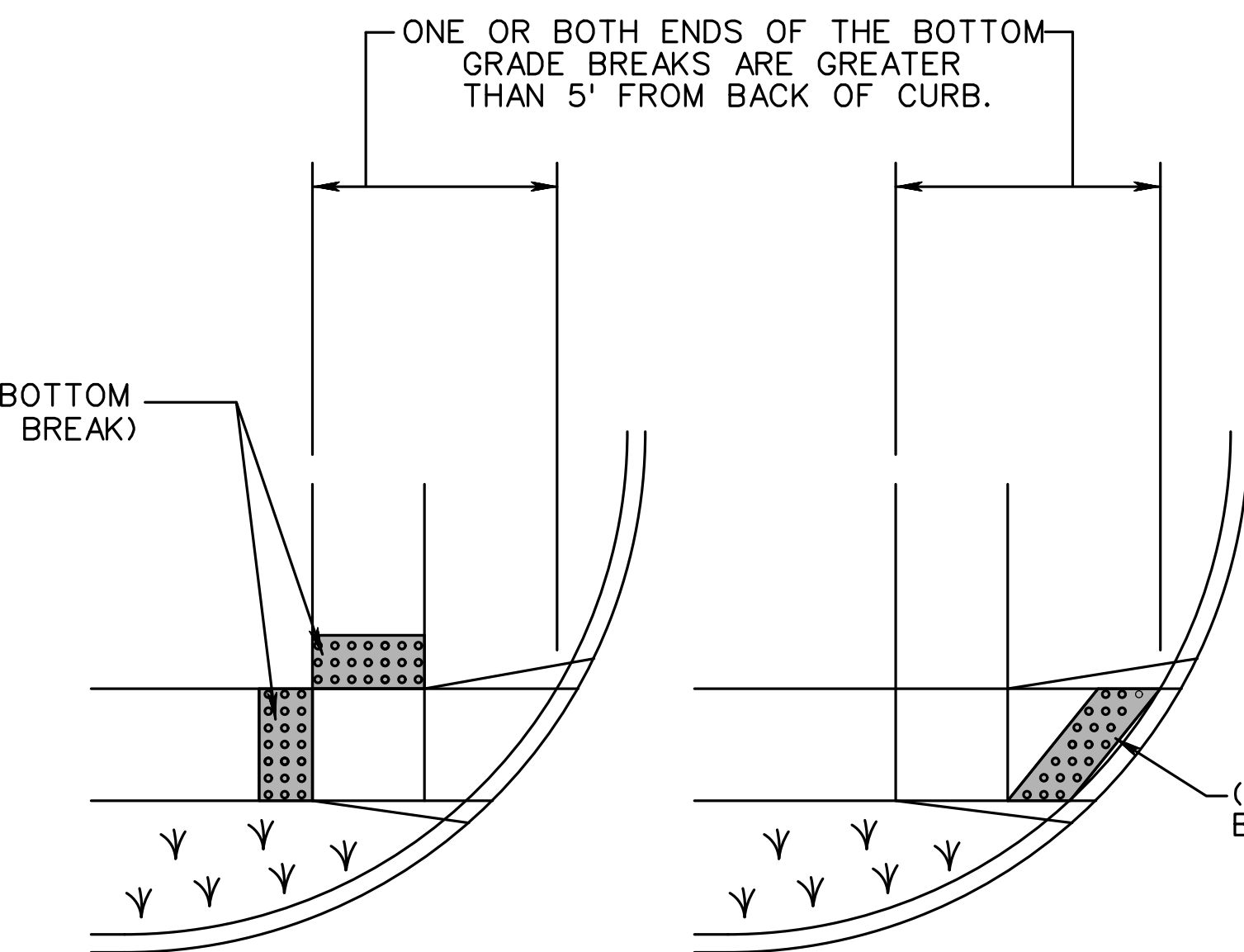
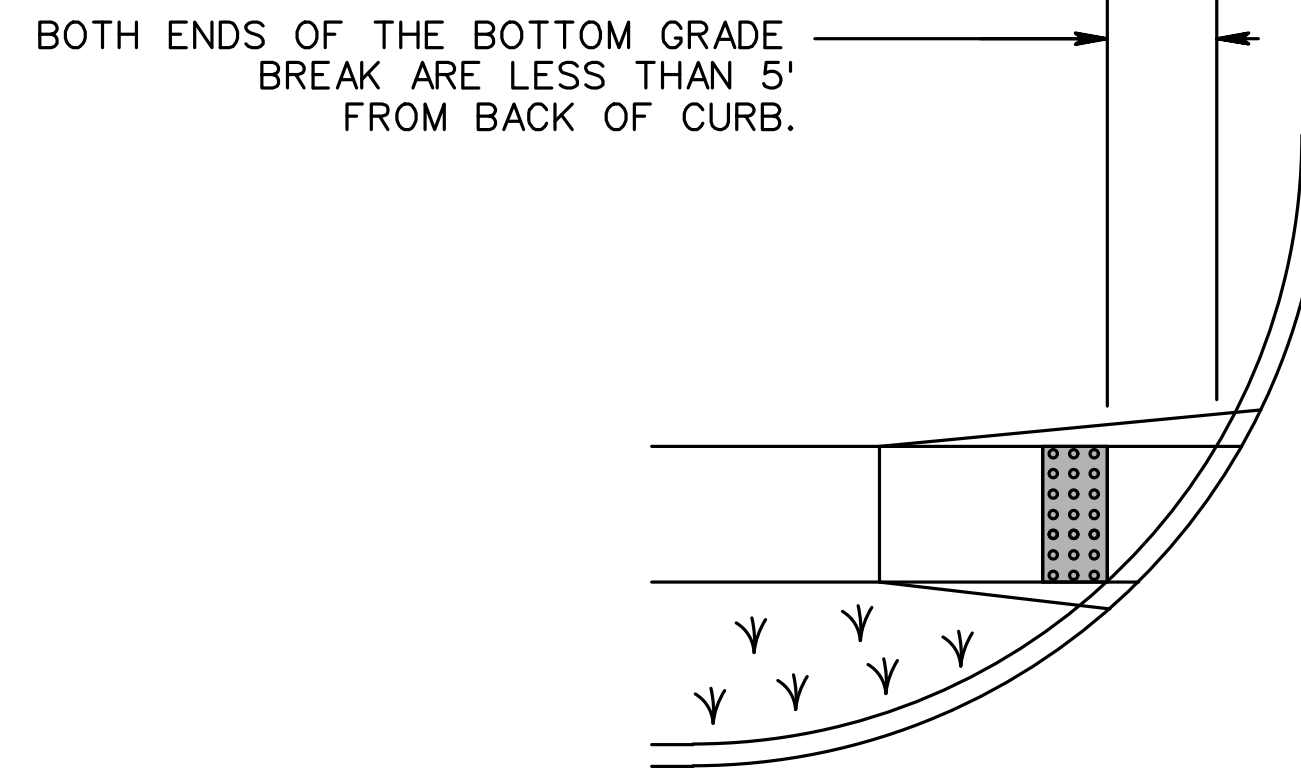

PLACEMENT OF DETECTABLE WARNING SURFACE FOR CURB RAMP TYPE 5 AND 6

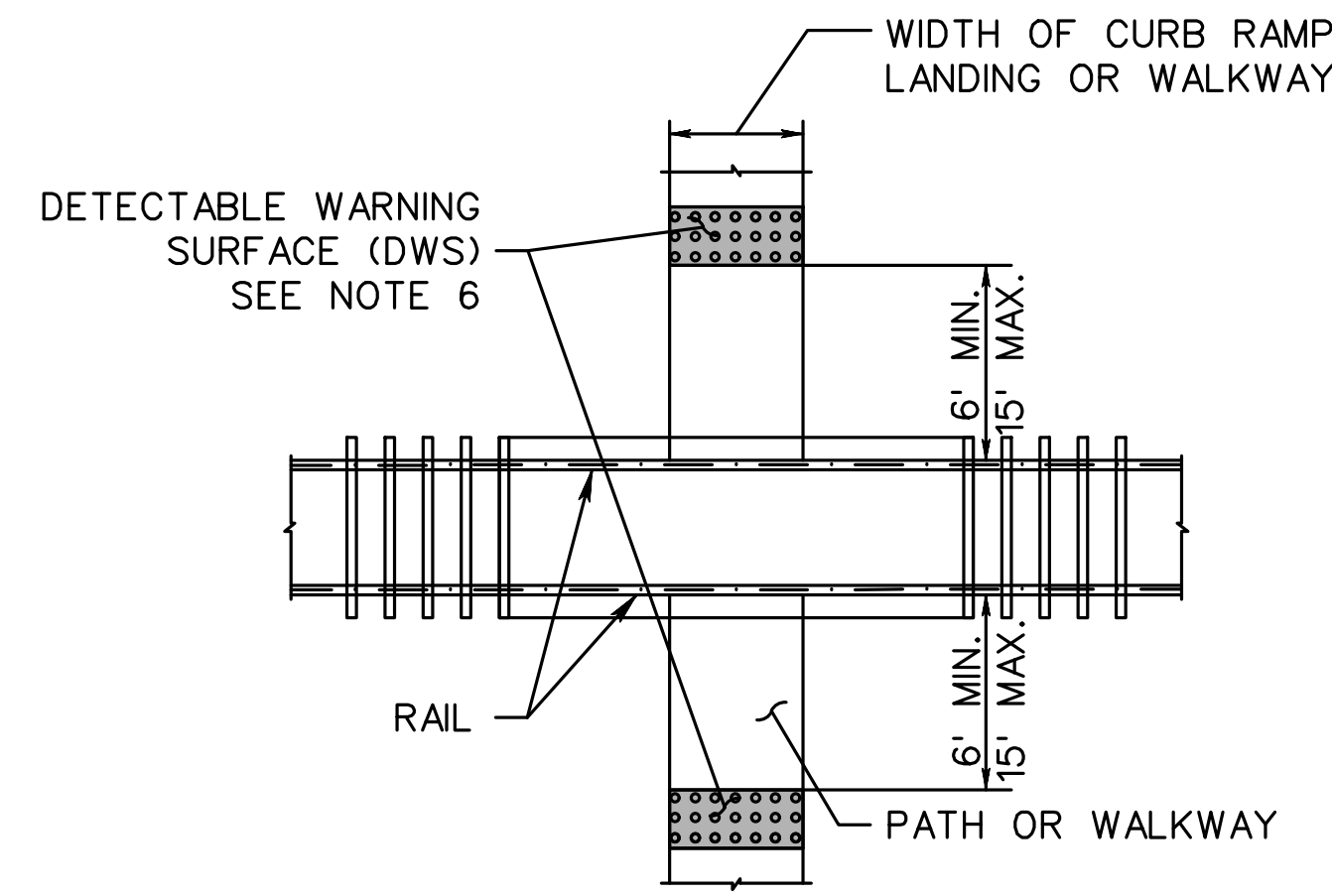
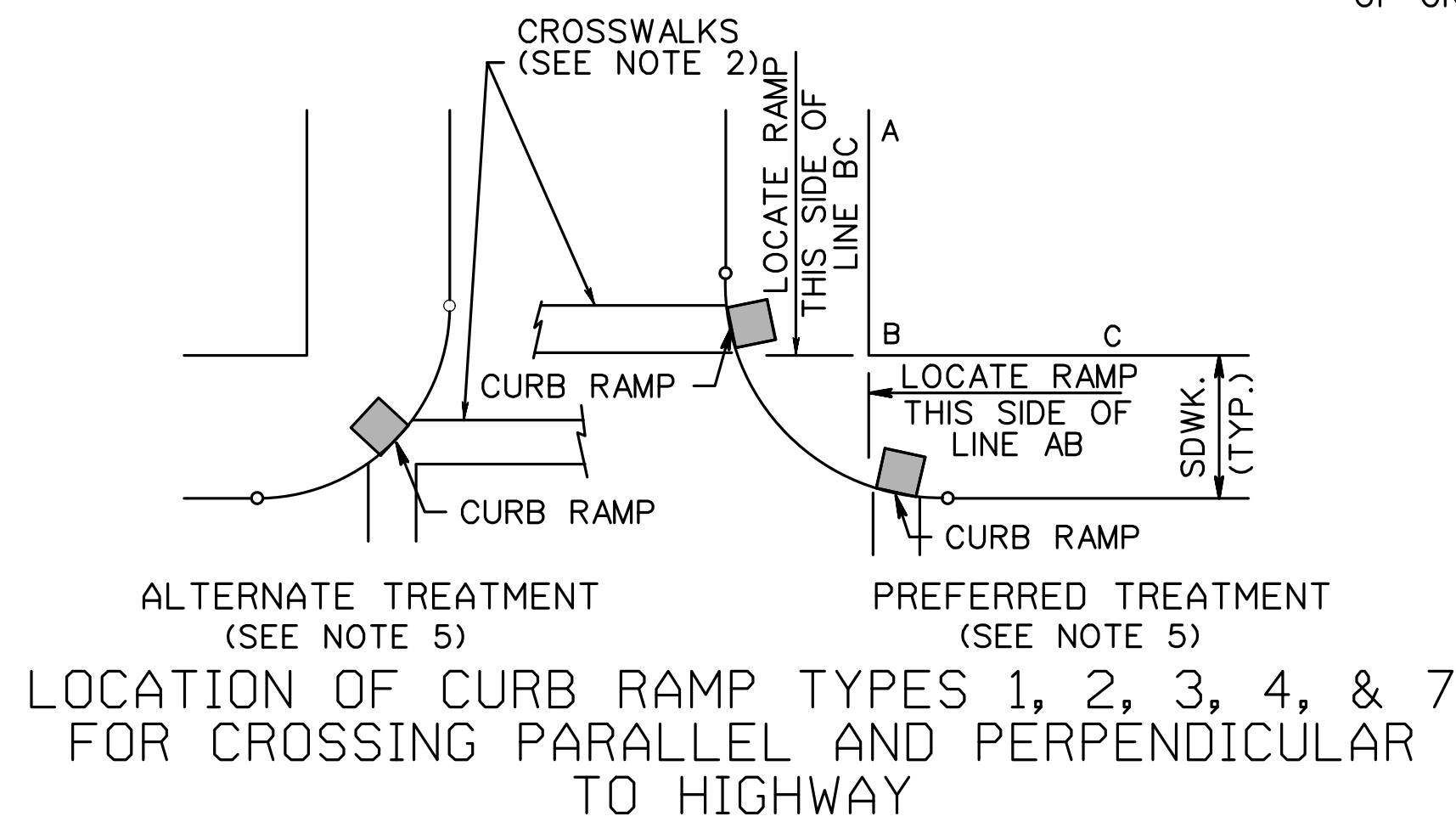

PEDESTRIAN RAILROAD CROSSING

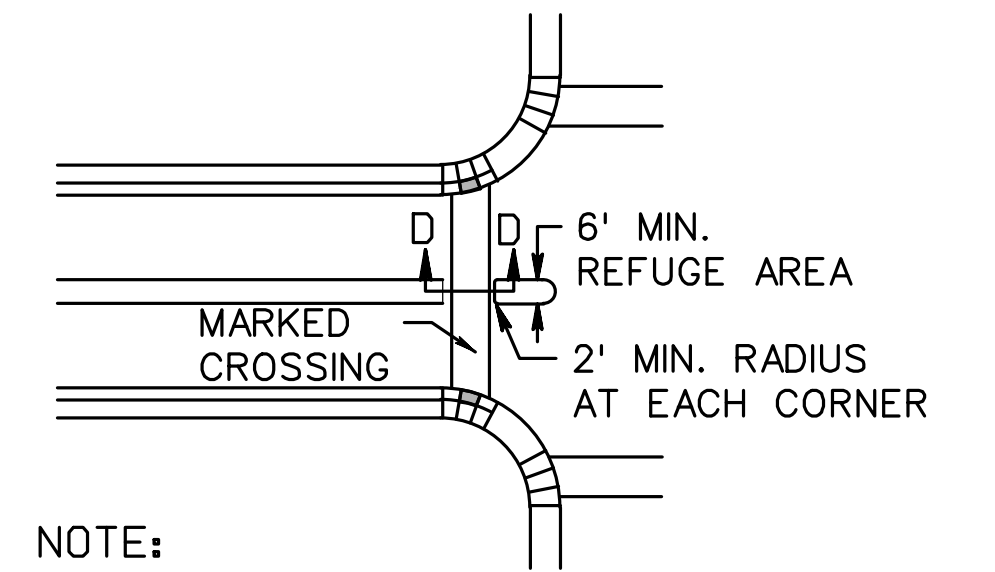

NOTE:
 WHERE PRACTICAL, END LEFT TURN ISLAND OR DIVISIONAL ISLAND BEFORE CROSSWALK TO ELIMINATE CUT-THROUGH

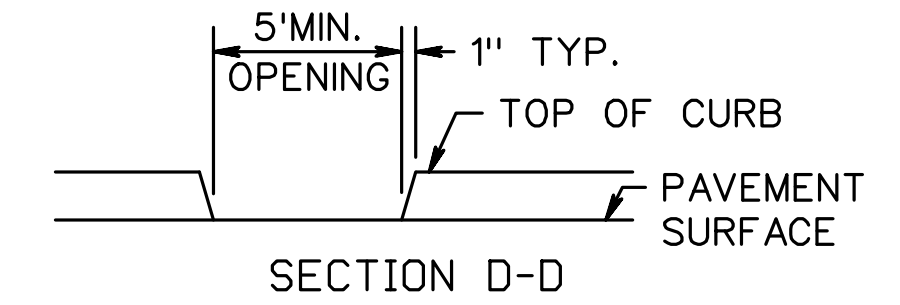

PEDESTRIAN REFUGE ISLAND WALKWAY OPENING AT INTERSECTIONS

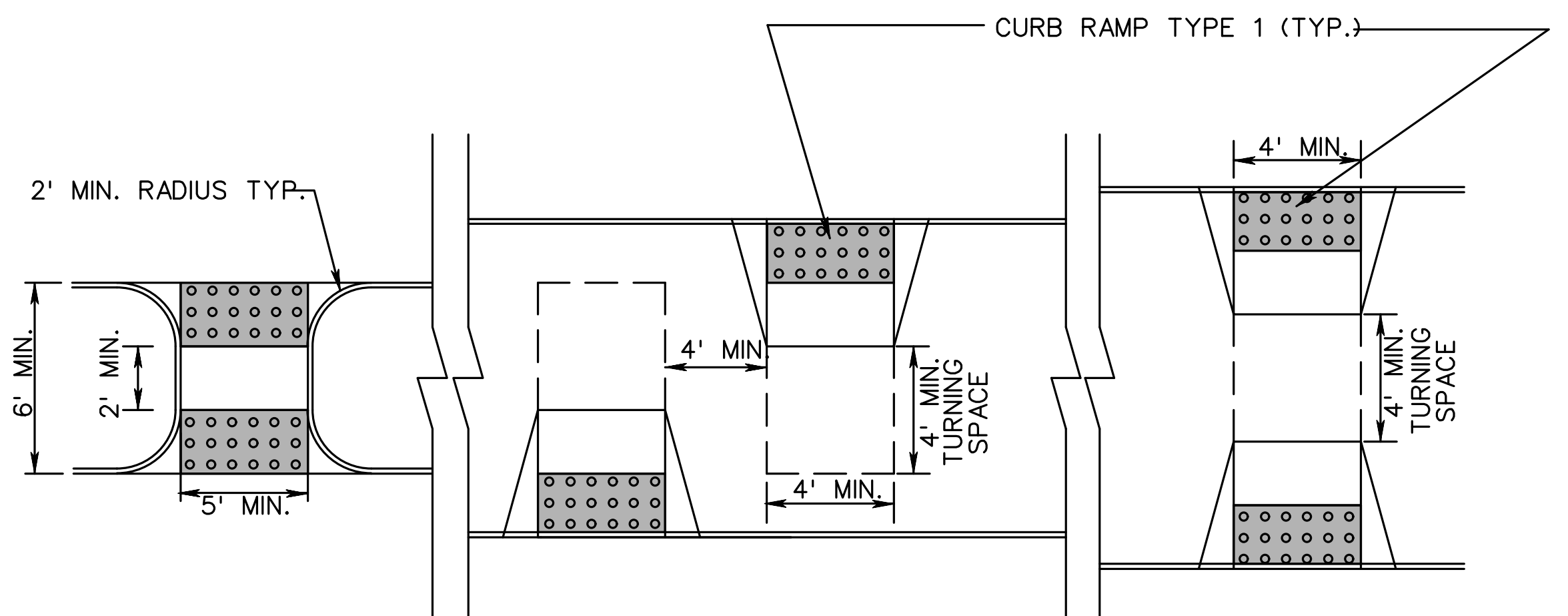

PEDESTRIAN REFUGE ISLAND

DETECTABLE WARNING SURFACE N.T.S.

- NOTES:
- KEEP TURNING SPACE, APPROACH SIDEWALK TRANSITIONS, AND CURB RAMP CLEAR OF OBSTRUCTIONS THAT PROTRUDE ABOVE THE SURFACE.
 - CROSSWALKS AND STOP LINES MAY BE MARKED OR UNMARKED, SEE PLANS.
 - FOR NARROW ISLAND WIDTH, SEE PEDESTRIAN REFUGE ISLAND WALKWAY OPENING AT INTERSECTIONS DETAIL.
 - FOR MEDIUM AND LARGE ISLAND WIDTH, SEE CURB RAMP TYPE 1 ON CD-606-1.
 - CONSTRUCT CURB RAMP TYPES 1, 2, 3, 4, & 7 PERPENDICULAR TO CURBLINE, AS SHOWN.
 - IF A CURB RAMP IS REQUIRED, THE LOCATION OF THE DETECTABLE WARNING SURFACE MUST BE AT THE BOTTOM OF THE RAMP AND WITHIN THE REQUIRED DISTANCE FROM THE RAIL.
 - A STANDARD DETECTABLE WARNING (DWS) SURFACE IS NOT AVAILABLE TO FIT THIS APPLICATION, AND THEREFORE ONE WILL NEED TO BE CUSTOMIZED. THE DWS SHOULD COVER THE ENTIRE WIDTH OF THE RAMP. THE ROWS OF DOMES ON THE DWS SHOULD FOLLOW THE DIRECTION OF TRAVEL OF THE RAMP, SO PEDESTRIANS WHO USE MOBILE DEVICES CAN TRACK BETWEEN THE DOMES.

NEW JERSEY DEPARTMENT OF TRANSPORTATION

CONSTRUCTION DETAILS

CD-606-2.1

CD-606-2

CURB RAMP TYPE 1

0.0 % GUTTER LINE PROFILE				
H INCHES	W FEET	X _{1U} FEET	X _{1L} FEET	L ₁ FEET
3	3	2.50	2.50	9.00
4	4	3.33	3.33	10.67
5	5	4.17	4.17	12.33
6	6	5.00	5.00	14.00
7	7	5.83	5.83	15.67
8	8	6.67	6.67	17.33
9	9	7.50	7.50	19.00

1.0 % GUTTER LINE PROFILE				
H INCHES	W FEET	X _{1U} FEET	X _{1L} FEET	L ₁ FEET
3	3	2.78	2.27	9.05
4	4	3.70	3.03	10.73
5	5	4.63	3.79	12.42
6	6	5.56	4.55	14.10
7	7	6.48	5.30	15.78
8	8	7.41	6.06	17.47
9	9	8.33	6.82	19.15

2.0 % GUTTER LINE PROFILE				
H INCHES	W FEET	X _{1U} FEET	X _{1L} FEET	L ₁ FEET
3	3	3.13	2.08	9.21
4	4	4.17	2.78	10.94
5	5	5.21	3.47	12.68
6	6	6.25	4.17	14.42
7	7	7.29	4.86	16.15
8	8	8.33	5.56	17.89
9	9	9.38	6.25	19.63

3.0 % GUTTER LINE PROFILE				
H INCHES	W FEET	X _{1U} FEET	X _{1L} FEET	L ₁ FEET
3	3	3.57	1.92	9.49
4	4	4.76	2.56	11.33
5	5	5.95	3.21	13.16
6	6	7.14	3.85	14.99
7	7	8.33	4.49	16.82
8	8	9.52	5.13	18.65
9	9	10.71	5.77	20.48

4.0 % GUTTER LINE PROFILE				
H INCHES	W FEET	X _{1U} FEET	X _{1L} FEET	L ₁ FEET
3	3	4.17	1.79	9.95
4	4	5.56	2.38	11.94
5	5	6.94	2.98	13.92
6	6	8.33	3.57	15.90
7	7	9.72	4.17	17.89
8	8	11.11	4.76	19.87
9	9	12.50	5.36	21.86

5.0 % GUTTER LINE PROFILE				
H INCHES	W FEET	X _{1U} FEET	X _{1L} FEET	L ₁ FEET
3	3	5.00	1.67	10.67
4	4	6.67	2.22	12.89
5	5	8.33	2.78	15.11
6	6	10.00	3.33	17.33
7	7	11.67	3.89	19.56
8	8	13.33	4.44	21.78
9	9	15.00	5.00	24.00

6.0 % GUTTER LINE PROFILE				
H INCHES	W FEET	X _{1U} FEET	X _{1L} FEET	L ₁ FEET
3	3	6.25	1.56	11.81
4	4	8.33	2.08	14.42
5	5	10.42	2.60	17.02
6	6	12.50	3.13	19.63
7	7	14.58	3.65	22.23
8	8	16.67	4.17	24.84
9	9	18.75	4.69	27.44

7.0 % GUTTER LINE PROFILE				
H INCHES	W FEET	X _{1U} FEET	X _{1L} FEET	L ₁ FEET
3	3	8.33	1.47	13.80
4	4	11.11	1.96	17.07
5	5	13.89	2.45	20.34
6	6	16.67	2.94	23.61
7	7	19.44	3.43	26.88
8	8	22.22	3.92	30.15
9	9	25.00	4.41	33.42

CURB RAMP TYPE 3

0.0 % GUTTER LINE PROFILE								
H INCHES	W FEET	X _{1U} FEET	X _{1L} FEET	L ₁ FEET	Y INCHES	X _{2U} FEET	X _{2L} FEET	L ₂ FEET
3		2.50	2.50	9.00		0.91	0.91	5.82
4		3.33	3.33	10.67		1.91	1.91	7.82
5		4.17	4.17	12.33		2.91	2.91	9.82
6	2.75	5.00	5.00	14.00	2.75	3.91	3.91	11.83
7		5.83	5.83	15.67		4.91	4.91	13.83
8		6.67	6.67	17.33		5.91	5.91	15.83
9		7.50	7.50	19.00		6.91	6.91	17.83

1.0 % GUTTER LINE PROFILE								
H INCHES	W FEET	X _{1U} FEET	X _{1L} FEET	L ₁ FEET	Y INCHES	X _{2U} FEET	X _{2L} FEET	L ₂ FEET
3		2.78	2.27	9.05		1.04	0.81	5.85
4		3.70	3.03	10.73		2.17	1.71	7.88
5		4.63	3.79	12.42		3.31	2.60	9.91
6	2.75	5.56	4.55	14.10	2.75	4.45	3.49	11.94
7		6.48	5.30	15.78		5.58	4.39	13.97
8		7.41	6.06	17.47		6.72	5.28	16.00
9		8.33	6.82	19.15		7.86	6.17	18.03

2.0 % GUTTER LINE PROFILE								
H INCHES	W FEET	X _{1U} FEET	X _{1L} FEET	L ₁ FEET	Y INCHES	X _{2U} FEET	X _{2L} FEET	L ₂ FEET
3		3.13	2.08	9.21		1.09	0.86	5.95
4		4.17	2.78	10.94		2.23	1.75	7.98
5		5.21	3.47	12.68		3.37	2.65	10.01
6	2.75	6.25	4.17	14.42	2.75	4.50	3.54	12.04
7		7.29	4.86	16.15		5.64	4.43	14.07
8		8.33	5.56	17.89		6.78	5.32	16.10
9		9.38	6.25	19.63				

3.0 % GUTTER LINE PROFILE								
H INCHES	W FEET	X _{1U} FEET	X _{1L} FEET	L ₁ FEET	Y INCHES	X _{2U} FEET	X _{2L} FEET	L ₂ FEET
3		3.57	1.92	9.49		1.13	1.00	6.04
4		4.76	2.56	11.33		2.27	2.09	8.07
5		5.95	3.21	13.16		3.41	3.08	10.10
6	2.75	7.14	3.85	14.99	2.75	4.55	4.17	12.13
7		8.33	4.49	16.82		5.69	5.28	14.16
8		9.52	5.13	18.65		6.83	6.42	16.19
9		10.71	5.77	20.48		7.97	7.51	18.22

4.0 % GUTTER LINE PROFILE								
H INCHES	W FEET	X _{1U} FEET	X _{1L} FEET	L ₁ FEET	Y INCHES	X _{2U} FEET	X _{2L} FEET	L ₂ FEET
3		4.17	1.79	9.95		1.17	1.17	6.13
4		5.56	2.38	11.94		2.34	2.34	8.16
5		6.94	2.98	13.92		3.51	3.51	10.19
6	2.75	8.33	3.57	15.90	2.75	4.68	4.68	12.22
7		9.72	4.17	17.89		5.85	5.85	14.25
8		11.11	4.76	19.87		7.02	7.02	16.28
9		12.50	5.36	21.86		8.19	8.19	18.31

5.0 % GUTTER LINE PROFILE								
H INCHES	W FEET	X _{1U} FEET	X _{1L} FEET	L ₁ FEET	Y INCHES	X _{2U} FEET	X _{2L} FEET	L ₂ FEET
3		5.00	1.67	10.67		1.21	1.21	6.22
4		6.67	2.22	12.89		2.38	2.38	8.25
5		8.33	2.78	15.11		3.55	3.55	10.28
6	2.75	10.00	3.33	17.33	2.75	4.72	4.72	12.31
7		11.67	3.89	19.56		5.89	5.89	14.34
8		13.33	4.44	21.78		7.06	7.06	16.37
9		15.00	5.00	24.00		8.23	8.23	18.40

6.0 % GUTTER LINE PROFILE								
H INCHES	W FEET	X _{1U} FEET	X _{1L} FEET	L ₁ FEET	Y INCHES	X _{2U} FEET	X _{2L} FEET	L ₂ FEET
3		6.25	1.56	11.81		1.25	1.25	6.31
4		8.33	2.08	14.42		2.42	2.42	8.34
5		10.42	2.60	17.02		3.59	3.59	10.37
6	2.75	12.50	3.13	19.63	2.75	4.76	4.76	12.40
7		14.58	3.65	22.23		5.93	5.93	14.43
8		16.67	4.17	24.84		7.10	7.10	16.46
9		18.75	4.69	27.44		8.27	8.27	18.49

7.0 % GUTTER LINE PROFILE								
H INCHES	W FEET	X _{1U} FEET	X _{1L} FEET	L ₁ FEET	Y INCHES	X _{2U} FEET	X _{2L} FEET	L ₂ FEET
3		8.33	1.47	13.80		1.29	1.29	6.40
4		11.11	1.96	17.07		2.46	2.46	8.43
5		13.89	2.45	20.34		3.63	3.63	10.46
6	2.75	16.67	2.94	23.61	2.75	4.80	4.80	12.49
7		19.44	3.43	26.88		5.97	5.97	14.52
8		22.22	3.92	30.15		7.14	7.14	16.55
9		25.00	4.41	33.42		8.31	8.31	18.58

0-8 % GUTTER LINE PROFILE				
H INCHES	W FEET	X _{1U} FEET	X _{1L} FEET	L ₁ FEET
3	3	1.50	1.50	7.00
4	4	1.50	1.50	7.00
5	5	1.50	1.50	7.00
6	6	1.50	1.50	7.00
7	7	1.50	1.50	7.00
8	8	1.50	1.50	7.00
9	9	1.50	1.50	7.00

1.0 % GUTTER LINE PROFILE								
H INCHES	W FEET	X _{1U} FEET	X _{1L} FEET	L ₁ FEET	Y INCHES	X _{2U} FEET	X _{2L} FEET	L ₂ FEET
3		2.78	2.27	9.05		1.04	0.81	5.85
4		3.70	3.03	10.73		2.17	1.71	7.88
5		4.63	3.79	12.42		3.31	2.60	9.91
6	2.75	5.56	4.55	14.10	2.75	4.45	3.49	11.94
7		6.48	5.30	15.78		5.58	4.39	13.97
8		7.41	6.06	17.47		6.72	5.28	16.00
9		8.33	6.82	19.15		7.86	6.17	18.03

2.0 % GUTTER LINE PROFILE								
H INCHES	W FEET	X _{1U} FEET	X _{1L} FEET	L ₁ FEET	Y INCHES	X _{2U} FEET	X _{2L} FEET	L ₂ FEET
3		3.13	2.08	9.21		1.09	0.86	5.95
4		4.17	2.78	10.94		2.23	1.75	7.98
5		5.21	3.47	12.68		3.37	2.65	10.01
6	2.75	6.25	4.17	14.42	2.75	4.50	3.54	12.04
7		7.29	4.86	16.15		5.64	4.43	14.07
8		8.33	5.56	17.89		6.78	5.32	16.10
9		9.38	6.25	19.63				

3.0 % GUTTER LINE PROFILE								
H INCHES	W FEET	X _{1U} FEET	X _{1L} FEET	L ₁ FEET	Y INCHES	X _{2U} FEET	X _{2L} FEET	L ₂ FEET
3		3.57	1.92	9.49		1.13	1.00	6.04
4		4.76	2.56	11.33		2.27	2.09	8.07
5		5.95	3.21	13.16		3.41	3.08	10.10
6	2.75	7.14	3.85	14.99	2.75	4.55	4.17	12.13
7		8.33	4.49	16.82		5.69	5.28	14.16

CURB RAMP TYPE 4

0.0 % GUTTER LINE PROFILE							
H INCHES	W FEET	Y INCHES	X _{2U} FEET	X _{2L} FEET	L ₂ FEET		
3	2.75	2.75	0.91	0.91	5.82		
4			1.91	1.91	7.82		
5			2.91	2.91	9.82		
6			3.91	3.91	11.82		
7			4.91	4.91	13.83		
8			5.91	5.91	15.83		
9			6.91	6.91	17.83		
3			**	**	**	**	**
4			1.72	1.72	7.44		
5	2.72	2.72	9.44				
6	3.72	3.72	11.45				
7	4.72	4.72	13.45				
8	5.72	5.72	15.45				
9	6.72	6.72	17.45				
3	**	**	**	**	**		
4	1.34	1.34	6.68				
5	2.34	2.34	8.68				
6	3.34	3.34	10.69				
7	4.34	4.34	12.69				
8	5.34	5.34	14.69				
9	6.34	6.34	16.69				
3	**	**	**	**	**		
4	1.96	1.96	7.92				
5	2.96	2.96	9.93				
6	3.96	3.96	11.93				
7	4.96	4.96	13.93				
8	5.96	5.96	15.93				
9	6.96	6.96	17.93				

1.0 % GUTTER LINE PROFILE					
H INCHES	W FEET	Y INCHES	X _{2U} FEET	X _{2L} FEET	L ₂ FEET
3	2.75	2.75	1.04	0.81	5.85
4			2.17	1.71	7.88
5			3.31	2.60	9.91
6			4.45	3.49	11.94
7			5.58	4.39	13.97
8			6.72	5.28	16.00
9			7.86	6.17	18.03
3			0.82	0.64	5.46
4			1.96	1.54	7.49
5	3.09	2.43	9.52		
6	4.23	3.32	11.55		
7	5.37	4.22	13.58		
8	6.50	5.11	15.61		
9	7.64	6.00	17.64		
3	0.39	0.30	4.69		
4	1.53	1.20	6.72		
5	2.66	2.09	8.75		
6	3.80	2.98	10.78		
7	4.94	3.88	12.81		
8	6.07	4.77	14.84		
9	7.21	5.66	16.87		
3	**	**	**	**	**
4	1.09	0.86	5.95		
5	2.23	1.75	7.98		
6	3.37	2.65	10.01		
7	4.50	3.54	12.04		
8	5.64	4.43	14.07		
9	6.78	5.32	16.10		

2.0 % GUTTER LINE PROFILE					
H INCHES	W FEET	Y INCHES	X _{2U} FEET	X _{2L} FEET	L ₂ FEET
3	2.75	2.75	1.20	0.73	5.93
4			2.52	1.54	8.06
5			3.83	2.35	10.18
6			5.15	3.16	12.30
7			6.47	3.96	14.43
8			7.78	4.77	16.55
9			9.10	5.58	18.67
3			0.95	0.58	5.53
4			2.27	1.39	7.65
5	3.58	2.20	9.78		
6	4.90	3.00	11.90		
7	6.22	3.81	14.02		
8	7.53	4.62	16.15		
9	8.85	5.42	18.27		
3	0.45	0.28	4.72		
4	1.77	1.08	6.85		
5	3.08	1.89	8.97		
6	4.40	2.70	11.09		
7	5.72	3.50	13.22		
8	7.03	4.31	15.34		
9	8.35	5.12	17.46		
3	**	**	**	**	**
4	1.27	0.78	6.04		
5	2.58	1.58	8.16		
6	3.90	2.39	10.29		
7	5.22	3.20	12.41		
8	6.53	4.00	14.53		
9	7.85	4.81	16.66		

3.0 % GUTTER LINE PROFILE					
H INCHES	W FEET	Y INCHES	X _{2U} FEET	X _{2L} FEET	L ₂ FEET
3	2.75	2.75	1.42	0.67	6.09
4			2.99	1.41	8.39
5			4.55	2.14	10.69
6			6.11	2.88	12.99
7			7.68	3.61	15.29
8			9.24	4.35	17.59
9			10.81	5.08	19.89
3			1.13	0.53	5.66
4			2.69	1.27	7.96
5	4.25	2.00	10.26		
6	5.82	2.74	12.55		
7	7.38	3.47	14.85		
8	8.94	4.21	17.15		
9	10.51	4.94	19.45		
3	0.53	0.25	4.78		
4	2.10	0.99	7.08		
5	3.66	1.72	9.38		
6	5.22	2.46	11.68		
7	6.79	3.19	13.98		
8	8.35	3.93	16.28		
9	9.91	4.66	18.58		
3	**	**	**	**	**
4	1.50	0.71	6.21		
5	3.07	1.44	8.51		
6	4.63	2.18	10.81		
7	6.19	2.91	13.11		
8	7.76	3.65	15.41		
9	9.32	4.38	17.71		

CURB RAMP TYPE 7

0.0 % GUTTER LINE PROFILE				
H INCHES	W FEET	X _{1U} FEET	X _{1L} FEET	L ₁ FEET
3	4' MIN. 7' MAX.	3.00	3.00	10.00
4		4.00	4.00	12.00
5		5.00	5.00	14.00
6		6.00	6.00	16.00
7		7.00	7.00	18.01
8		8.00	8.00	20.01
9		9.00	9.00	22.01

4.0 % GUTTER LINE PROFILE				
H INCHES	W FEET	X _{1U} FEET	X _{1L} FEET	L ₁ FEET
3	4' MIN. 7' MAX.	5.77	2.03	11.80
4		7.70	2.70	14.40
5		9.62	3.38	17.00
6		11.55	4.06	19.60
7		13.47	4.73	22.20
8		15.40	5.41	24.80
9		17.32	6.08	27.40

1.0 % GUTTER LINE PROFILE				
H INCHES	W FEET	X _{1U} FEET	X _{1L} FEET	L ₁ FEET
3	4' MIN. 7' MAX.	3.41	2.68	10.09
4		4.55	3.57	12.12
5		5.68	4.47	14.15
6		6.82	5.36	16.18
7		7.96	6.25	18.21
8		9.10	7.15	20.24
9		10.23	8.04	22.27

5.0 % GUTTER LINE PROFILE				
H INCHES	W FEET	X _{1U} FEET	X _{1L} FEET	L ₁ FEET
3	4' MIN. 7' MAX.	7.51	1.88	13.38
4		10.01	2.50	16.51
5		12.51	3.13	19.64
6		15.00	3.75	22.75
7		17.50	4.38	25.88
8		20.00	5.00	29.00
9		22.50	5.63	32.13

2.0 % GUTTER LINE PROFILE				
H INCHES	W FEET	X _{1U} FEET	X _{1L} FEET	L ₁ FEET
3	4' MIN. 7' MAX.	3.95	2.42	10.37
4		5.27	3.23	12.49
5		6.58	4.03	14.62
6		7.90	4.84	16.74
7		9.22	5.65	18.86
8		10.53	6.45	20.99
9		11.85	7.26	23.11

6.0 % GUTTER LINE PROFILE				
H INCHES	W FEET	X _{1U} FEET	X _{1L} FEET	L ₁ FEET
3	4' MIN. 7' MAX.	10.73	1.74	16.47
4		14.31	2.33	20.63
5		17.90	2.91	24.79
6		21.50	3.49	28.94
7		25.10	4.07	33.09
8		28.70	4.65	37.25
9		32.30	5.23	41.41

4.0 % GUTTER LINE PROFILE					
H INCHES	W FEET	Y INCHES	X _{2U} FEET	X _{2L} FEET	L ₂ FEET
3	2.75	2.75	1.75	0.62	6.37
4			3.68	1.29	8.97
5			5.60	1.97	11.57
6			7.53	2.64	14.17
7			9.45	3.32	16.77
8			11.38	4.00	19.37
9			13.30	4.67	21.97
3			1.39	0.49	5.88
4			3.31	1.16	8.48
5	5.24	1.84	11.08		
6	7.16	2.52	13.68		
7	9.09	3.19	16.28		
8	11.01	3.87	18.88		
9	12.94	4.54	21.48		
3	0.66	0.23	4.89		
4	2.58	0.91	7.49		
5	4.51	1.58	10.09		
6	6.43	2.26	12.69		
7	8.36	2.93	15.29		
8	10.28	3.61	17.89		
9	12.20	4.29	20.49		
3	**	**	**	**	**
4	1.85	0.65	6.50		
5	3.78	1.33	9.10		
6	5.70	2.00	11.70		
7	7.62	2.68	14.30		
8	9.55	3.35	16.90		
9	11.47	4.03	19.50		

5.0 % GUTTER LINE PROFILE					
H INCHES	W FEET	Y INCHES	X _{2U} FEET	X _{2L} FEET	L ₂ FEET
3	2.75	2.75	2.28	0.57	6.85
4			4.78	1.19	9.98
5			7.29	1.82	13.10
6			9.79	2.45	16.23
7			12.29	3.07	19.36
8			14.79	3.70	22.49
9			17.29	4.32	25.62
3			1.80	0.45	6.26
4			4.31	1.08	9.38
5	6.81	1.70	12.51		
6	9.31	2.33	15.64		
7	11.81	2.95	18.77		
8	14.32	3.58	21.89		
9	16.82	4.20	25.02		
3	0.85	0.21	5.07		
4	3.36	0.84	8.20		
5	5.86	1.46	11.32		
6	8.36	2.09	14.45		
7	10.86	2.71	17.58		
8	13.37	3.34	20.71		
9	15.87	3.96	23.84		
3	**	**	**	**	**
4	2.41	0.60	7.01		
5	4.91	1.23	10.14		
6	7.41	1.85	13.26		
7	9.91	2.48	16.39		
8	12.42	3.10	19.52		
9	14.92	3.73	22.65		

6.0 % GUTTER LINE PROFILE					
H INCHES	W FEET	Y INCHES	X _{2U} FEET	X _{2L} FEET	L ₂ FEET
3	2.75	2.75	3.26	0.53	7.79
4			6.84	1.11	11.95
5			10.41	1.69	16.10
6			13.99	2.27	20.26
7			17.57	2.86	24.41
8			21.15	3.44	28.57
9			24.73	4.02	32.72
3			2.58	0.42	7.00
4			6.16	1.00	11.16
5	9.73	1.58	15.31		
6	13.31	2.16	19.47		
7	16.89	2.75	23.62		
8	20.47	3.33	27.78		
9	24.05	3.91	31.93		
3	1.22	0.20	5.42		
4	4.80	0.78	9.58		
5	8.37	1.36	13.74		
6	11.95	1.94	17.89		
7	15.53	2.52	22.05		
8	19.11	3.10	26.20		
9	22.69	3.69	30.35		
3	**	**	**	**	**
4	3.44	0.56	8.00		
5	7.02	1.14	12.16		
6	10.59	1.72	16.31		
7	14.17	2.30	20.47		
8	17.75	2.89	24.62		
9	21.33	3.47	28.77		

7.0 % GUTTER LINE PROFILE					
H INCHES	W FEET	Y INCHES	X _{2U} FEET	X _{2L} FEET	L ₂ FEET
3	2.75	2.75	5.71	0.50	10.20
4			11.97	1.04	17.01
5			18.23	1.58	23.82
6			24.49	2.13	30.63
7			30.75	2.67	37.44
8			37.01	3.21	44.25
9			43.27	3.76	51.06
3			4.52	0.39	8.91
4			10.78	0.94	15.72
5	17.04	1.48	22.53		
6	23.30	2.02	29.34		
7	29.56	2.57	36.15		
8	35.82	3.11	42.96		
9	42.08	3			